

General Specifications

Motor Protection: Auto Restart/Polarity Protection
 Insulation Resistance: 10M Ohm or over with a DC500V Megger
 Dielectric Withstand Voltage: AC 700V 1st
 Allowable Ambient Temperature Range:
 -10 degree C ~ +70 degree C (Operating)
 -40 degree C ~ +70 degree C (Storage)
 (non-condensing environment)

Material

Casing: Plastic (Black) UL94V-0
 Impeller: Plastic (Black) UL94V-0
 Lead Wire: UL3385, AWG26, +Red, -Black

1608VL product picture



1608VL panel cut out

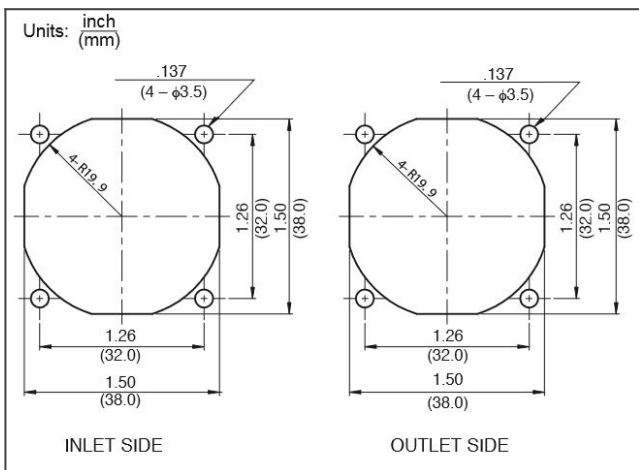

1608VL characteristic curve

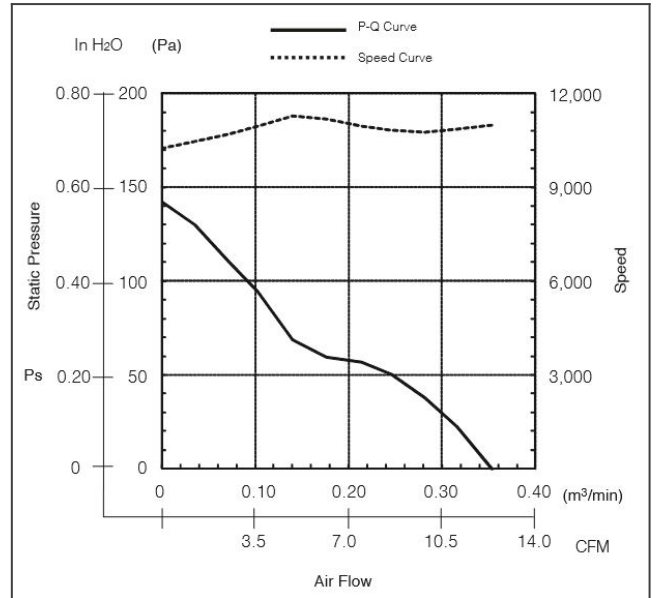

1608VL product drawing

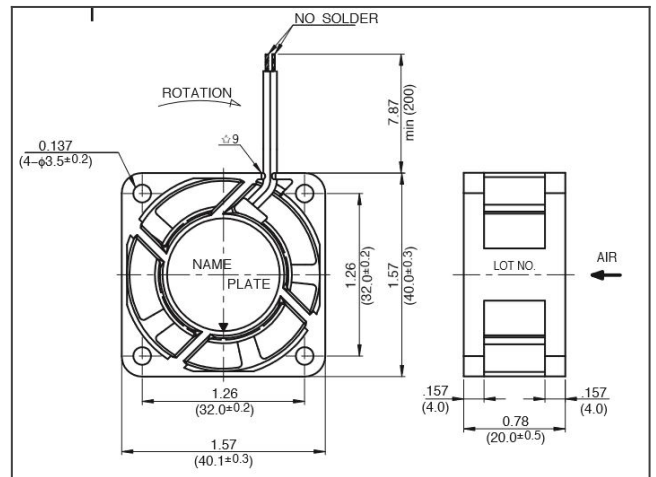

Detailed Specifications

Expected Life:	25 degree C 100,000 Hours (L10)
DC Fan:	Ball Bearing Fan
Nominal Voltage:	24
Operating Voltage Lower:	14
Operating Voltage Upper:	26.4
Current:	0.1
Input Power:	2.4
Speed:	9500
Max. Air Flow:	0.32
Max. Air Flow:	11.3
Max. Static Pressure:	99.3
Max. Static Pressure:	0.4
Noise:	34.6
Mass:	40
Fan Size:	40
Fan Width:	20

DC Fans