

IGBT MODULE (F series)

■ Features

- Low Saturation Voltage
- Voltage Drive
- Variety of Power Capacity Series

■ Applications

- Inverter for Motor Drive
- AC and DC Servo Drive Amplifier
- Uninterruptible Power Supply
- Industrial Machines, such as Welding Machines

■ Maximum Ratings and Characteristics

● Absolute Maximum Ratings

Items	Symbols	Ratings	Units	
Collector-Emitter Voltage	V _{CEs}	1200	V	
Gate-Emitter Voltage	V _{GES}	±20	V	
Collector Current	Continuous	150	A	
	1ms	I _{C pulse}		300
	Continuous	-I _C		150
	1ms	-I _{C pulse}		300
Max. Power Dissipation	P _C	1080	W	
Operating Temperature	T _j	+150	°C	
Storage Temperature	T _{stg}	-40 to +125	°C	
Net. Weight		400	g	
Isolation Voltage	AC. 1min.	V _{isol}	2500	V
Screw Torque	Mounting *1	3.5 {35}	N · m	
	Terminals *1	3.5 {35}	{kg · cm}	

*1 Recommendable Value 2.5 to 3.5 N·m {25 to 35 kg·cm} (M5)

● Electrical Characteristics (T_C=25°C)

Items	Symbols	Test Conditions	Min.	Typ.	Max.	Units
Zero Gate Voltage Collector Current	I _{CES}	V _{GE} =0V V _{CE} =1200V T _j =25°C			1.0	mA
		V _{GE} =0V V _{CE} =1200V T _j =125°C			—	mA
Gate-Emitter Leakage Current	I _{GES}	V _{CE} =0V V _{GE} =±20V			200	nA
Gate-Emitter Threshold Voltage	V _{GE(th)}	V _{CE} =20V I _C =150mA	3.0		6.0	V
Collector-Emitter Saturation Voltage	V _{CE(sat)}	V _{GE} =15V I _C =150A			2.5	V
Input Capacitance	C _{ies}	V _{GE} =0V		27000		pF
Output Capacitance	C _{oes}	V _{CE} =10V		—		
Reverse Transfer Capacitance	C _{res}	f=1MHz		—		
Turn-on Time	t _{on}	V _{CC} =600V	Resistive load		0.8	μs
	t _r	I _C =150A			0.6	
Turn-off Time	t _{off}	V _{GE} =±15V	Inductive load		1.5	
	t _f	R _G =5.6Ω			1.0	
Diode Forward On-Voltage	V _F	I _F =150A, V _{GE} =0V			2.5	V
Reverse Recovery Time	t _{rr}	I _F =150A, -di/dt=450A/μs V _{GE} =-10V			350	ns

● Thermal Characteristics

Items	Symbols	Test Conditions	Min.	Typ.	Max.	Units
Thermal Resistance	R _{th(j-c)}	IGBT			0.116	°C/W
	R _{th(j-e)}	Diode			0.222	
	R _{th(c-f)}	With Thermal compound		0.025		

■ Outline Drawings

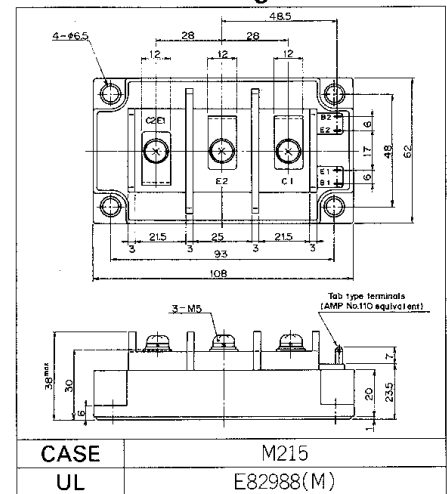

■ Equivalent Circuit Schematic

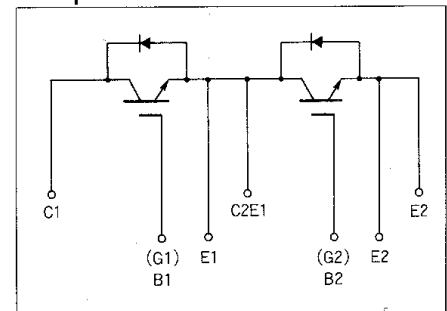

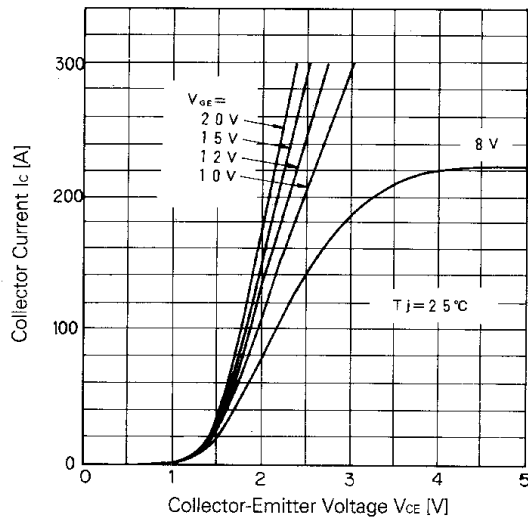

Collector Current vs. Collector-Emittor Voltage

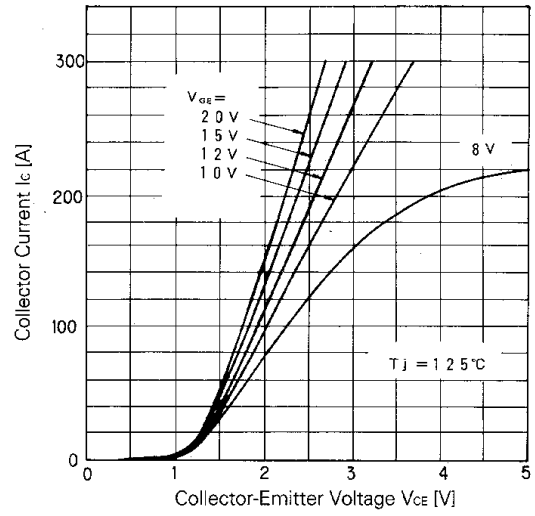

Collector Current vs. Collector-Emittor Voltage

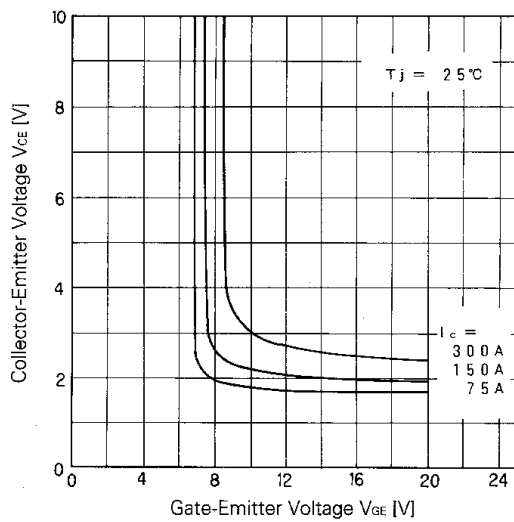

Collector-Emittor Voltage vs. Gate-Emittor Voltage

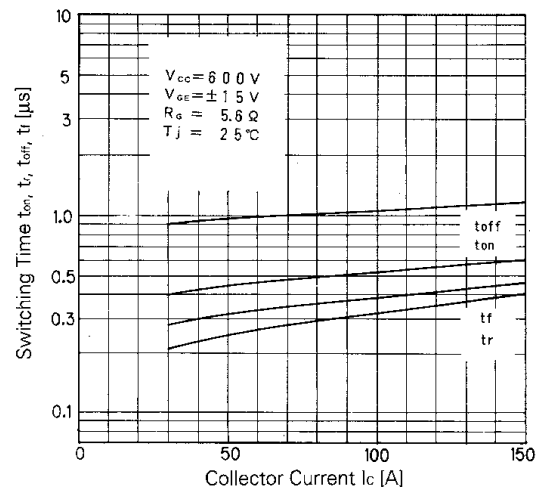

Switching Time

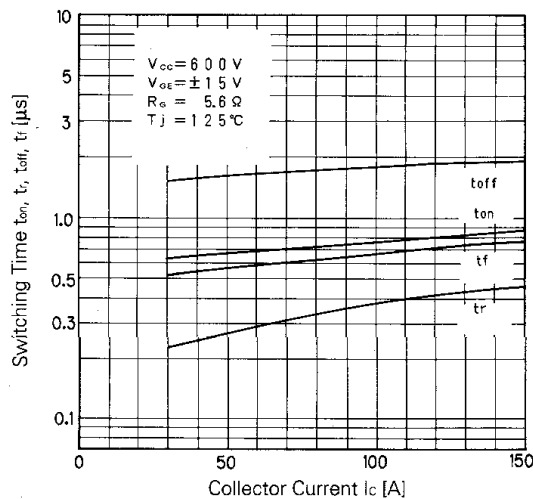

Switching Time

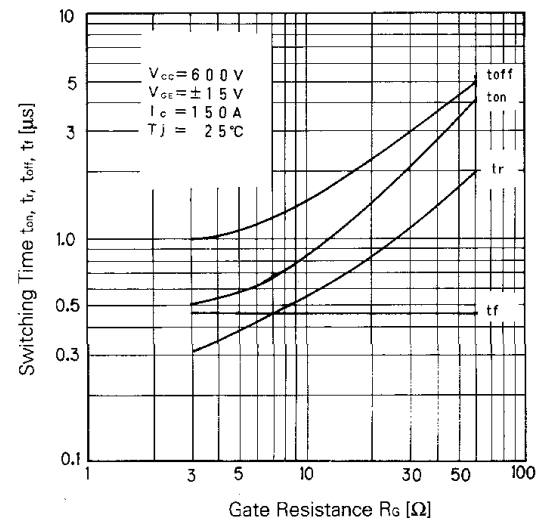

Switching Time-Gate Resistance

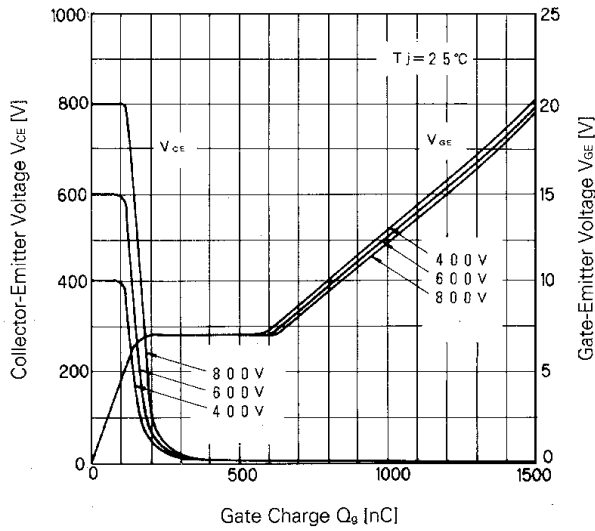

Dynamic Input Characteristic

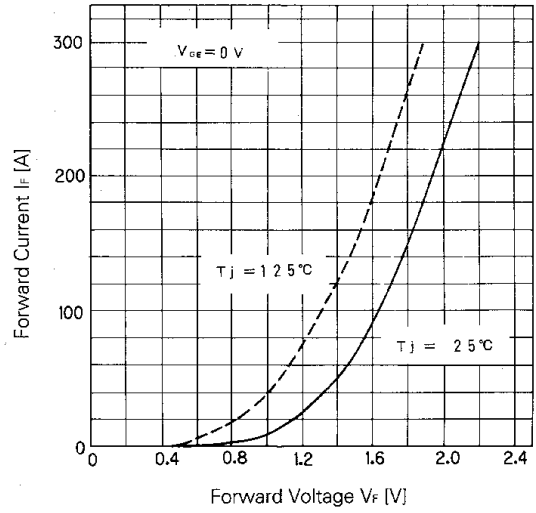

Forward Voltage of Free Wheel Diode

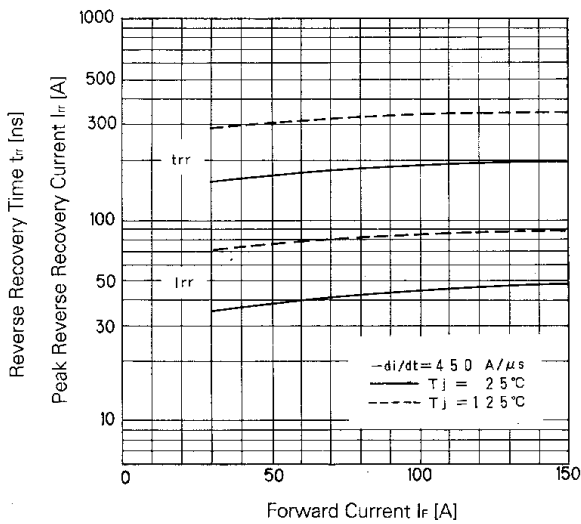

$T_{rr}, I_{rr} - I_f$

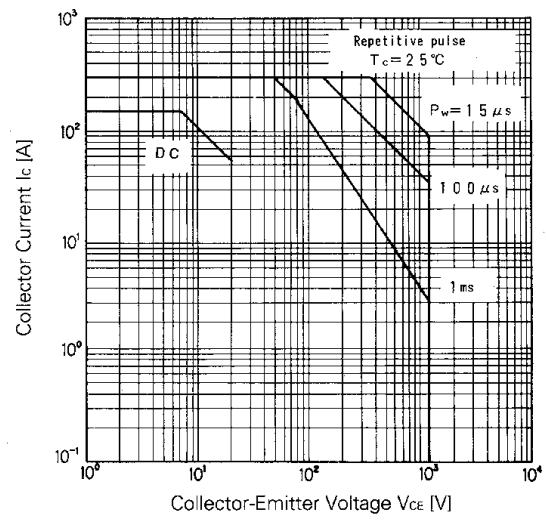

Safe Operating Area

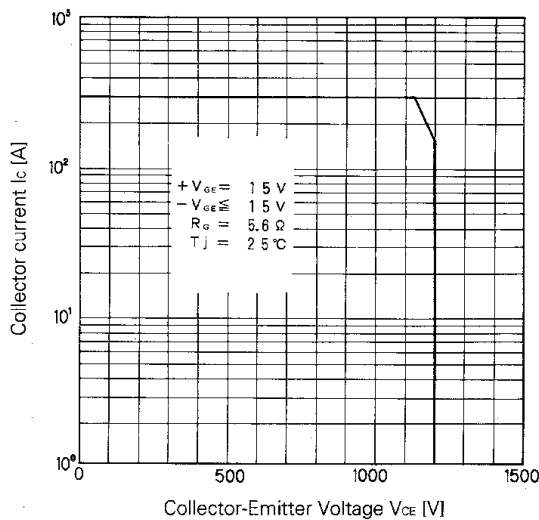

Reverse Biased Safe Operating Area

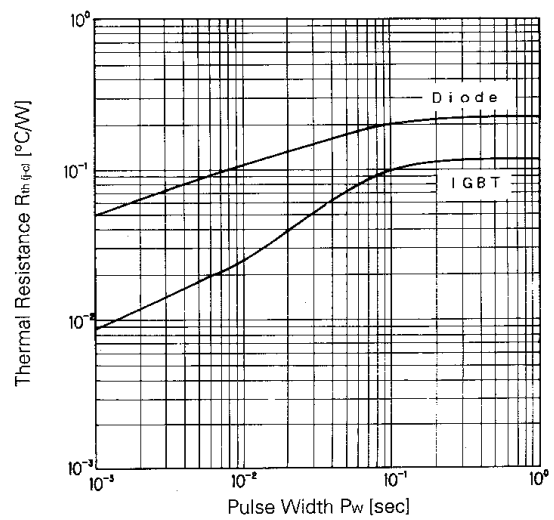

Transient Thermal Resistance

For more information, contact:

Collmer Semiconductor, Inc.

P.O. Box 702708

Dallas, TX 75370

972-733-1700

972-381-9991 Fax

<http://www.collmer.com>