

# 690/700 Volt PSC Square Body

Mersen 690/700V PSC square body fuses provide maximum flexibility in equipment design and ultimate protection for today's power conversion equipment. These square body fuses are available in four different body sizes, each size having more than seven worldwide acceptable mounting styles. The different mounting styles and body sizes along with a broad range of ampere ratings allow greatest flexibility in equipment design.

Mersen PSC fuses have been engineered to provide state-of-the-art protection for SCRs, diodes, thyristors, GTOs and IGBT devices. They have die-cut elements embedded in solidified sand, which helps control arcing characteristics for low  $I^2t$  and high interrupting rating. All contact surfaces are silver plated and all hardware is non-magnetic.

All PSC square body fuses are equipped with a low voltage trip-indicator. This trip-indicator can operate a field mountable microswitch which is easily mounted directly onto the fuse.

## Features/Benefits:

- Choice of mounting styles gives wide choice for equipment design
- Broad range of ampere ratings in a given body size for design flexibility
- UL/CSA/IEC 60269-4 compliance for worldwide semiconductor applications

## Highlights:

- Extremely fast-acting
- Current-limiting
- Very low  $I^2t$
- Worldwide acceptability
- Superior cycling ability

## Applications:

- Protection of rectifiers, inverters, DC drives, UPS Systems, reduced voltage motor starters, and other equipment in globally accepted applications

## Catalog Number Designation:

**A070 UR:** North American Mounting Style/Approval Tested @  $V_N$

**PC:** European/IEC Mounting Style/Approval Tested @  $1.1 V_N$

\* $V_N$  = rated voltage

### N. American Catalog Numbering System

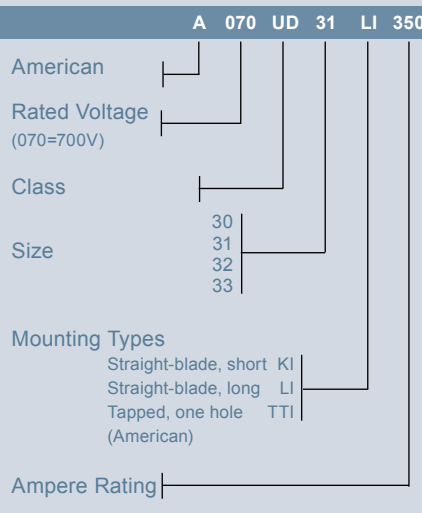

### European Catalog Numbering System

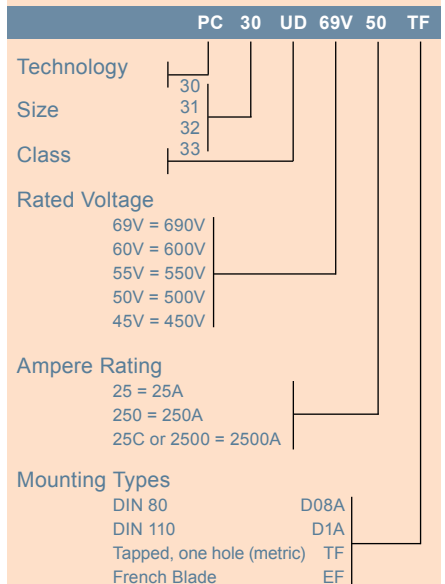

## Ratings:

**Volts** : 450-700 VAC  
           : DC - consult factory  
**Amps** : 40-2500A  
**I.R.** : 200kA AC

## Approvals:

- UL recognized component File E76491
- IEC 60269-4 certified
- CSA 012636 0 000
- CCC approved



# 690/700 Volt PSC Square Body

## North American Short Straight Blade, Type KI

Body Size	Type	Dimensions - mm / in								
		A	B	C	D	E	F	G	H	J
30	KI	40 (1.57)	25 (.98)	12.5 (.49)	21 (.83)	18 (.71)	68 (2.68)	107 (4.21)	129 (5.08)	10.5 (.41)
31		51 (2.00)	25 (.98)	12.5 (.49)	25.5 (1.00)	22.5 (.88)	67.6 (2.66)	107.1 (4.216)	128.8 (5.07)	14.3 (.56)
32		60 (2.36)	32 (1.26)	16 (.63)	30 (1.18)	27 (1.06)	74.2 (2.92)	109 (4.29)	134 (5.28)	14.6 (.57)
33		74.5 (2.93)	40 (1.57)	20 (.79)	37.2 (1.46)	34.2 (1.35)	75.4 (2.97)	107.6 (4.24)	134 (5.28)	15.9 (.63)

## Outline Dimensions: Types KI and LI

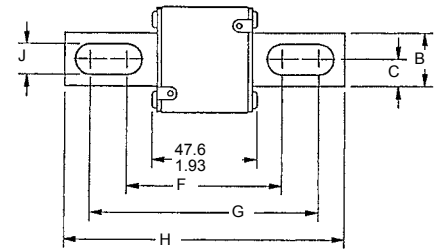

## North American Long Straight Blade, Type LI

Body Size	Type	Dimensions - mm / in								
		A	B	C	D	E	F	G	H	J
30	LI	40 (1.57)	25 (.98)	12.5 (.49)	21 (.83)	18 (.71)	87.6 (3.45)	126.6 (4.98)	148.6 (5.85)	10.5 (.41)
31		51 (2.01)	25 (.98)	12.5 (.49)	25.5 (1.00)	22.5 (.89)	91.6 (3.61)	122.4 (4.82)	148.6 (5.85)	14.6 (.57)
32		60 (2.36)	32 (1.26)	16 (.63)	30 (1.18)	27 (1.06)	94.2 (3.71)	129 (5.08)	153 (6.02)	14.6 (.57)
33		74.5 (2.93)	40 (1.57)	20 (.79)	37.2 (1.46)	34.2 (1.35)	94.4 (3.72)	126.6 (4.98)	153 (6.02)	15.9 (.63)

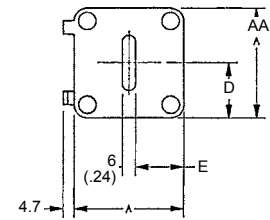

## European Blade DIN 80, Type D08A

Body Size	Type	Dimensions - mm						
		A	B	C	D	E	F	G
30	DIN 80	40	25	12.5	21	17	77	110
31		51	25	12.5	25	22.5	77	110
32		60	32	16	30	27	77	110
33		74.5	40	20	37.2	34.25	77	110

## Outline Dimensions: Types D08A and D1A

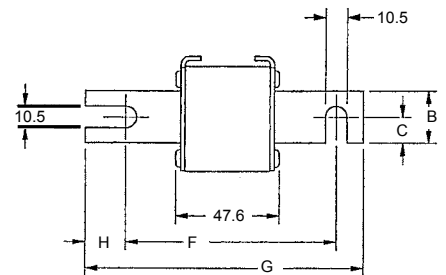

## European Blade DIN 110, Type D1A

Body Size	Type	Dimensions - mm						
		A	B	C	D	E	F	G
30	DIN 110	40	25	12.5	21	17	101.6	134.6
31		51	25	12.5	25.5	22.5	101.6	134.6
32		60	32	16	30	27	101.6	134.6
33		74.5	40	20	37.2	34.25	101.6	134.6

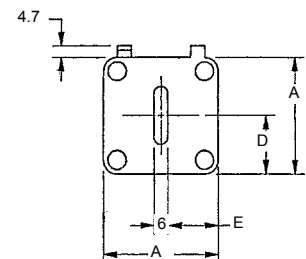

# 690/700 Volt PSC Square Body

## North American Tap Single Hole, Type TTI

Body Size	Type	Dimensions - mm / in		
		A	B	C
30	TTI	1.57 (40)	1.00 (25)	5/16-18 x .35
31		2.00 (50.8)	1.19 (30.2)	5/16-18 x .35
32		2.37 (60.3)	1.50 (38.1)	3/8-16 x .35
33		2.94 (74.6)	1.81 (46)	1/2-13 x .35

## Outline Dimensions

### Types TTI and TTF

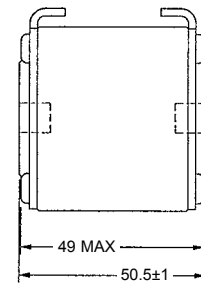
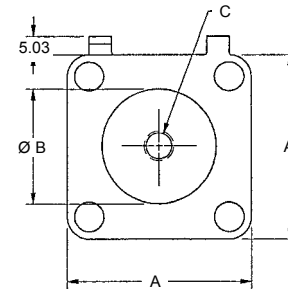

## European Tap Single Hole, Type TTF

Body Size	Type	Dimensions - mm		
		A	B	C
30	TTF	40	26	M8 x 1.25 x 6 DP
31		51	30	M8 x 1.25 x 9 DP
32		60	38	M10 x 1.50 x 9 DP
33		74.5	46	M12 x 1.75 x 9 DP

## Standard Threaded Studs

Size	Reference No. per Pair	Dimension Per Pair of Studs	Weight (g)	Max Stud Mounting Torque (Nm)*	Max Nut Tightening Torque (Nm)*		
					Fig. 1	Fig. 2	Fig. 3
30 & 31	S98801	HC M8 X 30 & M 8 X 35	23	10	13.5	13.5	13.5
32	T98802	HC M 10 X 30 & M 10 X 50	40	15	26	26	26
33	V98803	HC M 12 X 35 & M 12 X 50	60		46	46	46

\*in.lbs = Nm/0.113

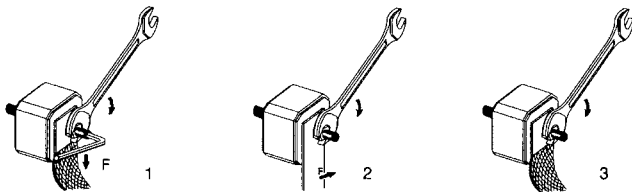

## Type EF

## European French Blade, Type EF

Body Size	Type	Dimensions - mm					
		A	B	C	D	E	F
30	EF	40	18	11	9	100	76.6
31		50	25	16	10.5	110	86.5
32		59	32	21.2	13	13	90.8
33		74.5	40	19.5	13	13	91

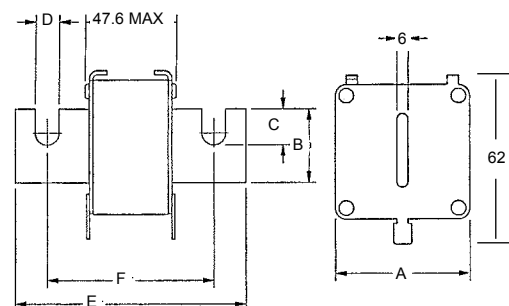

# 690/700 Volt PSC Square Body

## 690 Volt European/IEC Style Ratings and Application Data, DIN 110 Mounting

Body Size	Ampere Rating $I_n$ (A)	Rated Voltage $V_n$ (V) (IEC)	Melting $I^2t$ ( $A^2s \times 10^3$ )	Total Clearing $I^2t$ @ $V_n$ ( $A^2s \times 10^3$ )	Watts Loss @ $I_n$ (W)	Reference No.	Catalog No.	Description
30	50	690	0.116	0.68	9	G301191	PC30UD69V50D1A	6,9URD30D11A0050
	63	690	0.2	1.2	14	Q300118	PC30UD69V63D1A	6,9URD30D11A0063
	80	690	0.33	1.9	19	R300119	PC30UD69V80D1A	6,9URD30D11A0080
	100	690	0.47	2.7	26	S300120	PC30UD69V100D1A	6,9URD30D11A0100
	125	690	0.85	4.9	30	T300121	PC30UD69V125D1A	6,9URD30D11A0125
	160	690	1.6	9.2	37	V300122	PC30UD69V160D1A	6,9URD30D11A0160
	200	690	3	16.7	43	W300123	PC30UD69V200D1A	6,9URD30D11A0200
	250	690	5.8	32.4	50	X300124	PC30UD69V250D1A	6,9URD30D11A0250
	315	690	12	67	55	Y300125	PC30UD69V315D1A	6,9URD30D11A0315
	350	690	15.5	86	60	Z300126	PC30UD69V350D1A	6,9URD30D11A0350
	400	690	23	130	65	A300127	PC30UD69V400D1A	6,9URD30D11A0400
	450	690	26	165	88	S300695	PC30UD69V450D1A	6,9URD30D11A0450
	500	690	41	264	88	Y301091	PC30UD69V500D1A	6,9URD30D11A0500
	550	690	52	330	90	Z301092	PC30UD69V550D1A	6,9URD30D11A0550
31	200	690	2.6	14.6	45	H300019	PC31UD69V200D1A	6,9URD31D11A0200
	250	690	4.7	27	52	J300020	PC31UD69V250D1A	6,9URD31D11A0250
	315	690	7.5	43	65	K300021	PC31UD69V315D1A	6,9URD31D11A0315
	350	690	10.5	59	67	P300048	PC31UD69V350D1A	6,9URD31D11A0350
	400	690	19	110	68	L300022	PC31UD69V400D1A	6,9URD31D11A0400
	450	690	26.5	150	70	M300023	PC31UD69V450D1A	6,9URD31D11A0450
	500	690	37	210	72	N300024	PC31UD69V500D1A	6,9URD31D11A0500
	550	690	52	300	75	P300025	PC31UD69V550D1A	6,9URD31D11A0550
	630	690	75	421	85	Q300026	PC31UD69V630D1A	6,9URD31D11A0630
	700	690	95	530	95	R300027	PC31UD69V700D1A	6,9URD31D11A0700
800	690	140	880	120	H300709	PC31UD69V800D1A	6,9URD31D11A0800	
32	400	690	15	86	75	P300186	PC32UD69V400D1A	6,9URD32D11A0400
	450	690	22	124	80	Q300187	PC32UD69V450D1A	6,9URD32D11A0450
	500	690	28	157	90	R300188	PC32UD69V500D1A	6,9URD32D11A0500
	550	690	37	211	95	S300189	PC32UD69V550D1A	6,9URD32D11A0550
	630	690	54	302	105	T300190	PC32UD69V630D1A	6,9URD32D11A0630
	700	690	76	432	110	V300191	PC32UD69V700D1A	6,9URD32D11A0700
	800	690	115	648	120	W300192	PC32UD69V800D1A	6,9URD32D11A0800
	900	690	170	972	125	X300193	PC32UD69V900D1A	6,9URD32D11A0900
	1000	690	240	1350	135	Y300194	PC32UD69V10CD1A	6,9URD32D11A1000
33	500	690	19	108	105	S300258	PC33UD69V500D1A	6,9URD33D11A0500
	550	690	27	151	110	T300259	PC33UD69V550D1A	6,9URD33D11A0550
	630	690	40	227	120	V300260	PC33UD69V630D1A	6,9URD33D11A0630
	700	690	55	324	125	W300261	PC33UD69V700D1A	6,9URD33D11A0700
	800	690	95	529	130	X300262	PC33UD69V800D1A	6,9URD33D11A0800
	900	690	135	760	135	Y300263	PC33UD69V900D1A	6,9URD33D11A0900
	1000	690	170	970	155	Z300264	PC33UD69V10CD1A	6,9URD33D11A1000
	1100	690	240	1360	160	A300265	PC33UD69V11CD1A	6,9URD33D11A1100
	1250	690	350	2000	180	B300266	PC33UD69V12CD1A	6,9URD33D11A1250
	1400	690	480	2700	200	C300267	PC33UD69V14CD1A	6,9URD33D11A1400
	1500	600	500		220	H301974	PC33UD60V15CD1A	6URD33D11A1500
1600	600	555	3250	240	Z301437	PC33UD60V16CD1A	6URD33D11A1600	

# 690/700 Volt PSC Square Body

## 690 Volt European/IEC Style Ratings and Application Data, DIN 80 Mounting

Body Size	Ampere Rating $I_n$ (A)	Rated Voltage $V_n$ (V) (IEC)	Melting $I^2t$ ( $A^2s \times 10^3$ )	Total Clearing $I^2t$ @ $V_n$ ( $A^2s \times 10^3$ )	Watts Loss @ $I_n$ (W)	Reference No.	Catalog No.	Description
30	50	690	0.116	0.68	9	F301926	PC30UD69V50A	6,9URD30D08A0050
	63	690	0.2	1.2	14	E300108	PC30UD69V63A	6,9URD30D08A0063
	80	690	0.33	1.9	19	F300109	PC30UD69V80A	6,9URD30D08A0080
	100	690	0.47	2.7	26	G300110	PC30UD69V100A	6,9URD30D08A0100
	125	690	0.85	4.3	30	H300111	PC30UD69V125A	6,9URD30D08A0125
	160	690	1.6	9.2	37	J300112	PC30UD69V160A	6,9URD30D08A0160
	200	690	3	16.7	43	K300113	PC30UD69V200A	6,9URD30D08A0200
	250	690	5.8	32.4	50	L300114	PC30UD69V250A	6,9URD30D08A0250
	315	690	12	67	55	M300115	PC30UD69V315A	6,9URD30D08A0315
	350	690	15.5	86	60	N300116	PC30UD69V350A	6,9URD30D08A0350
	400	690	23	130	65	P300117	PC30UD69V400A	6,9URD30D08A0400
	450	690	26	165	88	A300403	PC30UD69V450A	6,9URD30D08A0450
	500	690	41	256	88	B300404	PC30UD69V500A	6,9URD30D08A0500
	550	690	52	330	90	C300405	PC30UD69V550A	6,9URD30D08A0550
31	200	690	2.6	14.6	45	Y300010	PC31UD69V200A	6,9URD31D08A0200
	250	690	4.7	27	52	Z300011	PC31UD69V250A	6,9URD31D08A0250
	315	690	7.5	43	65	A300012	PC31UD69V315A	6,9URD31D08A0315
	350	690	10.5	59	67	Q300049	PC31UD69V350A	6,9URD31D08A0350
	400	690	19	110	68	B300013	PC31UD69V400A	6,9URD31D08A0400
	450	690	26.5	150	70	C300014	PC31UD69V450A	6,9URD31D08A0450
	500	690	37	210	72	D300015	PC31UD69V500A	6,9URD31D08A0500
	550	690	52	300	75	E300016	PC31UD69V550A	6,9URD31D08A0550
	630	690	75	421	85	F300017	PC31UD69V630A	6,9URD31D08A0630
	700	690	95	530	95	G300018	PC31UD69V700A	6,9URD31D08A0700
32	400	690	15	86	75	E300177	PC32UD69V400A	6,9URD32D08A0400
	450	690	22	124	80	F300178	PC32UD69V450A	6,9URD32D08A0450
	500	690	28	157	90	G300179	PC32UD69V500A	6,9URD32D08A0500
	550	690	37	211	95	H300180	PC32UD69V550A	6,9URD32D08A0550
	630	690	54	302	105	J300181	PC32UD69V630A	6,9URD32D08A0630
	700	690	76	432	110	K300182	PC32UD69V700A	6,9URD32D08A0700
	800	690	115	648	120	L300183	PC32UD69V800A	6,9URD32D08A0800
	900	690	170	972	125	M300184	PC32UD69V900A	6,9URD32D08A0900
	1000	690	240	1350	135	N300185	PC32UD69V1000A	6,9URD32D08A1000
	1100	600	270	1450	165	W302101	PC32UD60V1100A	6URD32D08A1100
33	1250	550	410	1950	180	G300409	PC32UD50V1250A	5,5URD32D08A1250
	500	690	19	108	105	G300248	PC33UD69V500A	6,9URD33D08A0500
	550	690	27	151	110	H300249	PC33UD69V550A	6,9URD33D08A0550
	630	690	40	227	120	J300250	PC33UD69V630A	6,9URD33D08A0630
	700	690	55	324	125	K300251	PC33UD69V700A	6,9URD33D08A0700
	800	690	95	529	130	L300252	PC33UD69V800A	6,9URD33D08A0800
	900	690	135	760	135	M300253	PC33UD69V900A	6,9URD33D08A0900
	1000	690	170	970	155	N300254	PC33UD69V1000A	6,9URD33D08A1000
	1100	690	240	1360	160	P300255	PC33UD69V1100A	6,9URD33D08A1100
	1250	690	350	2000	180	Q300256	PC33UD69V1250A	6,9URD33D08A1250
	1400	690	480	2700	200	R300257	PC33UD69V1400A	6,9URD33D08A1400
	1500	600	500		220	M235071	PC33UD60V1500A	6URD33D08A1500
	1600	600	555	3250	240	X301803	PC33UD60V1600A	6URD33D08A1600
1800	600	720		260	E301971	PC33UD60V1800A	6URD33D08A1800	

# 690/700 Volt PSC Square Body

## 690 Volt European/IEC Style Ratings and Application Data, EF Mounting

Body Size	Ampere Rating $I_n$ (A)	Rated Voltage $V_n$ (V) (IEC)	Melting $I^2t$ ( $A^2s \times 10^3$ )	Total Clearing $I^2t$ @ $V_n$ ( $A^2s \times 10^3$ )	Watts Loss @ $I_n$ (W)	Reference No.	Catalog No.	Description
30	50	690	0.116	0.68	9	R300372	PC30UD69V50EF	6,9URD30EF0050
	63	690	0.2	1.2	14	H300088	PC30UD69V63EF	6,9URD30EF0063
	80	690	0.33	1.9	19	J300089	PC30UD69V80EF	6,9URD30EF0080
	100	690	0.47	2.7	26	K300090	PC30UD69V100EF	6,9URD30EF0100
	125	690	0.85	4.9	30	L300091	PC30UD69V125EF	6,9URD30EF0125
	160	690	1.6	9.2	37	M300092	PC30UD69V160EF	6,9URD30EF0160
	200	690	3	16.7	43	N300093	PC30UD69V200EF	6,9URD30EF0200
	250	690	5.8	32.4	50	P300094	PC30UD69V250EF	6,9URD30EF0250
	315	690	12	67	55	Q300095	PC30UD69V315EF	6,9URD30EF0315
	350	690	15.5	86	60	R300096	PC30UD69V350EF	6,9URD30EF0350
	400	690	23	130	65	S300097	PC30UD69V400EF	6,9URD30EF0400
31	200	690	2.6	14.6	45	C300037	PC31UD69V200EF	6,9URD31EF0200
	250	690	4.7	27	52	D300038	PC31UD69V250EF	6,9URD31EF0250
	315	690	7.5	43	65	E300039	PC31UD69V315EF	6,9URD31EF0315
	350	690	10.5	59	67	N300047	PC31UD69V350EF	6,9URD31EF0350
	400	690	19	110	68	F300040	PC31UD69V400EF	6,9URD31EF0400
	450	690	26.5	150	70	G300041	PC31UD69V450EF	6,9URD31EF0450
	500	690	37	210	72	H300042	PC31UD69V500EF	6,9URD31EF0500
	550	690	52	300	75	J300043	PC31UD69V550EF	6,9URD31EF0550
	630	690	75	421	85	K300044	PC31UD69V630EF	6,9URD31EF0630
700	690	95	530	95	L300045	PC31UD69V700EF	6,9URD31EF0700	
32	400	690	15	86	75	V300168	PC32UD69V400EF	6,9URD32EF0400
	450	690	22	124	80	W300169	PC32UD69V450EF	6,9URD32EF0450
	500	690	28	157	90	X300170	PC32UD69V500EF	6,9URD32EF0500
	550	690	37	211	95	Y300171	PC32UD69V550EF	6,9URD32EF0550
	630	690	54	302	105	Z300172	PC32UD69V630EF	6,9URD32EF0630
	700	690	76	432	110	A300173	PC32UD69V700EF	6,9URD32EF0700
	800	690	115	648	120	B300174	PC32UD69V800EF	6,9URD32EF0800
	900	690	170	972	125	C300175	PC32UD69V900EF	6,9URD32EF0900
	1000	690	240	1350	135	D300176	PC32UD69V1000EF	6,9URD32EF1000
33	500	690	19	108	105	Z300218	PC33UD69V500EF	6,9URD33EF0500
	550	690	27	151	110	A300219	PC33UD69V550EF	6,9URD33EF0550
	630	690	40	227	120	B300220	PC33UD69V630EF	6,9URD33EF0630
	700	690	55	324	125	C300221	PC33UD69V700EF	6,9URD33EF0700
	800	690	95	529	130	D300222	PC33UD69V800EF	6,9URD33EF0800
	900	690	135	760	135	E300223	PC33UD69V900EF	6,9URD33EF0900
	1000	690	170	970	155	F300224	PC33UD69V1000EF	6,9URD33EF1000
	1100	690	240	1360	160	G300225	PC33UD69V1100EF	6,9URD33EF1100
	1250	690	350	2000	180	H300226	PC33UD69V1250EF	6,9URD33EF1250
	1400	6960	480	2700	200	J300227	PC33UD69V1400EF	6,9URD33EF1400

# 690/700 Volt PSC Square Body

## 690 Volt European/IEC Style Ratings and Application Data, TTF Mounting

Body Size	Ampere Rating $I_n$ (A)	Rated Voltage $V_n$ (V) (IEC)	Melting $I^2t$ ( $A^2s \times 10^3$ )	Total Clearing $I^2t$ @ $V_n$ ( $A^2s \times 10^3$ )	Watts Loss @ $I_n$ (W)	Reference No.	Catalog No.	Description
30	50	690	0.116	0.68	9	S300373	PC30UD69V50TF	6,9URD30TTF0050
	63	690	0.2	1.2	14	M300000	PC30UD69V63TF	6,9URD30TTF0063
	80	690	0.33	1.9	19	S300051	PC30UD69V80TF	6,9URD30TTF0080
	100	690	0.47	2.7	26	T300052	PC30UD69V100TF	6,9URD30TTF0100
	125	690	0.85	4.9	30	V300053	PC30UD69V125TF	6,9URD30TTF0125
	160	690	1.6	9.2	37	W300054	PC30UD69V160TF	6,9URD30TTF0160
	200	690	3	16.7	42	X300055	PC30UD69V200TF	6,9URD30TTF0200
	250	690	5.8	32.4	48	Y300056	PC30UD69V250TF	6,9URD30TTF0250
	315	690	12	67	53	Z300057	PC30UD69V315TF	6,9URD30TTF0315
	350	690	15.5	86	57	A300058	PC30UD69V350TF	6,9URD30TTF0350
	400	690	23	130	60	B300059	PC30UD69V400TF	6,9URD30TTF0400
	450	690	26	165	80	V300398	PC30UD69V450TF	6,9URD30TTF0450
	500	690	41	264	80	W300399	PC30UD69V500TF	6,9URD30TTF0500
	550	690	52	330	80	X300400	PC30UD69V550TF	6,9URD30TTF0550
31	200	690	2.6	14.6	45	N300001	PC31UD69V200TF	6,9URD31TTF0200
	250	690	4.7	27	52	P300002	PC31UD69V250TF	6,9URD31TTF0250
	315	690	7.5	43	65	Q300003	PC31UD69V315TF	6,9URD31TTF0315
	350	690	10.5	59	67	M300046	PC31UD69V350TF	6,9URD31TTF0350
	400	690	19	110	68	R300004	PC31UD69V400TF	6,9URD31TTF0400
	450	690	26.5	150	70	S300005	PC31UD69V450TF	6,9URD31TTF0450
	500	690	37	210	70	T300006	PC31UD69V500TF	6,9URD31TTF0500
	550	690	52	300	70	V300007	PC31UD69V550TF	6,9URD31TTF0550
	630	690	75	421	75	W300008	PC31UD69V630TF	6,9URD31TTF0630
	700	690	95	530	85	X300009	PC31UD69V700TF	6,9URD31TTF0700
	800	690	140	880	105	Y300401	PC31UD69V800TF	6,9URD31TTF0800
32	400	690	15	86	72	H300065	PC32UD69V400TF	6,9URD32TTF0400
	450	690	22	124	77	J300066	PC32UD69V450TF	6,9URD32TTF0450
	500	690	28	157	85	K300067	PC32UD69V500TF	6,9URD32TTF0500
	550	690	37	211	90	L300068	PC32UD69V550TF	6,9URD32TTF0550
	630	690	54	302	95	M300069	PC32UD69V630TF	6,9URD32TTF0630
	700	690	76	432	100	N300070	PC32UD69V700TF	6,9URD32TTF0700
	800	690	115	648	110	P300071	PC32UD69V800TF	6,9URD32TTF0800
	900	690	170	972	110	Q300072	PC32UD69V900TF	6,9URD32TTF0900
	1000	690	240	1350	115	S300074	PC32UD69V1000TF	6,9URD32TTF1000
	1100	600	270	1450	140	M300759	PC32UD60V1100TF	6URD32TTF1100
	1250	500	410	1950	150	P301060	PC32UD55V1250TF	5,5URD32TTF1250
33	500	690	19	108	105	V300076	PC33UD69V500TF	6,9URD33TTF0500
	550	690	27	151	105	W300077	PC33UD69V550TF	6,9URD33TTF0550
	630	690	40	227	110	X300078	PC33UD69V630TF	6,9URD33TTF0630
	700	690	55	324	115	Y300079	PC33UD69V700TF	6,9URD33TTF0700
	800	690	95	529	120	Z300080	PC33UD69V800TF	6,9URD33TTF0800
	900	690	135	760	120	A300081	PC33UD69V900TF	6,9URD33TTF0900
	1000	690	170	970	135	B300082	PC33UD69V1000TF	6,9URD33TTF1000
	1100	690	240	1360	135	C300083	PC33UD69V1100TF	6,9URD33TTF1100
	1250	690	350	2000	150	D300084	PC33UD69V1250TF	6,9URD33TTF1250
	1400	690	480	2700	160	E300085	PC33UD69V1400TF	6,9URD33TTF1400
	1500	600	500		220	Y300585	PC33UD60V1500TF	6URD33TTF1500
	1600	600	555	3250	210	Z300586	PC33UD60V1600TF	6URD33TTF1600
	1800	600	720		225	A300587	PC33UD60V1800TF	6URD33TTF1800
	2000	550	950		250	B300588	PC33UD55V2000TF	5,5URD33TTF2000
	2250	500	1250		280	K300757	PC33UD50V2250TF	5URD33TTF2250
	2500	450	1870		280	L300758	PC33UD45V2500TF	4,5URD33TTF2500

# 690/700 Volt PSC Square Body

## 700 Volt North American Style Ratings and Application Data, LI Mounting

Body Size	Ampere Rating $I_n$ (A)	Rated Voltage $V_n$ (V)	Melting I <sup>2</sup> t (A <sup>2</sup> s x 10 <sup>3</sup> )	Total Clearing I <sup>2</sup> t @ $V_n$ (A <sup>2</sup> s x 10 <sup>3</sup> )	Watts Loss @ $I_n$ (W)	Reference No.	Catalog No.	Description
30	63	700	0.2	1.2	14	M300138	A070UD30LI63	A070URD30LI0063
	80	700	0.33	1.9	19	N300139	A070UD30LI080	A070URD30LI0080
	100	700	0.47	2.7	26	P300140	A070UD30LI100	A070URD30LI0100
	125	700	0.85	4.9	30	Q300141	A070UD30LI125	A070URD30LI0125
	160	700	1.6	9.2	37	R300142	A070UD30LI160	A070URD30LI0160
	200	700	3	16.7	43	S300143	A070UD30LI200	A070URD30LI0200
	250	700	5.8	32.4	50	T300144	A070UD30LI250	A070URD30LI0250
	315	700	12	67	55	V300145	A070UD30LI315	A070URD30LI0315
	350	700	15.5	86	60	W300146	A070UD30LI350	A070URD30LI0350
	400	700	23	130	65	X300147	A070UD30LI400	A070URD30LI0400
	450	700	26	165	88	K300527	A070UD30LI450	A070URD30LI0450
	500	700	41	264	88	L300528	A070UD30LI500	A070URD30LI0500
	550	700	52	330	90	M300529	A070UD30LI550	A070URD30LI0550
31	200	700	2.6	14.6	45	V300697	A070UD31LI200	A070URD31LI0200
	250	700	4.7	27	52	W300698	A070UD31LI250	A070URD31LI0250
	315	700	7.5	43	65	X300699	A070UD31LI315	A070URD31LI0315
	350	700	10.5	59	67	Y300700	A070UD31LI350	A070URD31LI0350
	400	700	19	110	68	Z300701	A070UD31LI400	A070URD31LI0400
	450	700	26.5	150	70	A300702	A070UD31LI450	A070URD31LI0450
	500	700	37	210	72	B300703	A070UD31LI500	A070URD31LI0500
	550	700	52	300	75	C300704	A070UD31LI550	A070URD31LI0550
	630	700	75	421	85	D300705	A070UD31LI630	A070URD31LI0630
	700	700	95	530	95	E300706	A070UD31LI700	A070URD31LI0700
800	700	140	880	120	F300707	A070UD31LI800	A070URD31LI0800	
32	400	700	15	86	75	J300204	A070UD32LI400	A070URD32LI0400
	450	700	22	124	80	K300205	A070UD32LI450	A070URD32LI0450
	500	700	28	157	90	L300206	A070UD32LI500	A070URD32LI0500
	550	700	37	211	95	M300207	A070UD32LI550	A070URD32LI0550
	630	700	54	302	105	N300208	A070UD32LI630	A070URD32LI0630
	700	700	76	432	110	P300209	A070UD32LI700	A070URD32LI0700
	800	700	115	648	120	Q300210	A070UD32LI800	A070URD32LI0800
	900	700	170	972	125	R300211	A070UD32LI900	A070URD32LI0900
	1000	700	240	1350	135	S300212	A070UD32LI1000	A070URD32LI1000
	1100	650	270	1620	165	B301071	A065UD32LI1100	A065URD32LI1100
	1250	600	410	2100	180	C301072	A060UD32LI1250	A060URD32LI1250
	1400	550	555	2600	190	D301073	A055UD32LI1400	A055URD32LI1400
	1600	550	870	4000	195	E301074	A055UD32LI1600	A055URD32LI1600
1800	500	1050	4400	330	F301075	A050UD32LI1800	A050URD32LI1800	
33	500	700	19	108	105	K300228	A070UD33LI500	A070URD33LI0500
	550	700	27	151	110	L300229	A070UD33LI550	A070URD33LI0550
	630	700	40	227	120	M300230	A070UD33LI630	A070URD33LI0630
	700	700	55	324	125	N300231	A070UD33LI700	A070URD33LI0700
	800	700	95	529	130	P300232	A070UD33LI800	A070URD33LI0800
	900	700	135	760	135	Q300233	A070UD33LI900	A070URD33LI0900
	1000	700	170	970	155	R300234	A070UD33LI1000	A070URD33LI1000
	1100	700	240	1360	160	S300235	A070UD33LI1100	A070URD33LI1100
	1250	700	350	2000	180	T300236	A070UD33LI1250	A070URD33LI1250
	1400	700	480	2700	200	V300237	A070UD33LI1400	A070URD33LI1400
	1600	650	555	3250	240	G301076	A065UD33LI1600	A065URD33LI1600
	1800	650	720	4330	260	H301077	A065UD33LI1800	A065URD33LI1800
	2000	600	950	5000	290	J301078	A060UD33LI2000	A060URD33LI2000
	2250	550	1250	5900	330	K301079	A055UD33LI2250	A055URD33LI2250
	2500	500	1870	7600	330	L301080	A050UD33LI2500	A050URD33LI2500

For the most current product performance data visit [ep-us.mersen.com](http://ep-us.mersen.com) and use catalog search.



# 690/700 Volt PSC Square Body

## 700 Volt North American Style Ratings and Application Data, KI Mounting

Body Size	Ampere Rating $I_n$ (A)	Rated Voltage $V_n$ (V)	Melting $I^2t$ ( $A^2s \times 10^3$ )	Total Clearing $I^2t$ @ $V_n$ ( $A^2s \times 10^3$ )	Watts Loss @ $I_n$ (W)	Reference No.	Catalog No.	Description
30	63	700	0.2	1.2	14	B300128	A070UD30KI63	A070URD30KI0063
	80	700	0.33	1.9	19	C300129	A070UD30KI80	A070URD30KI0080
	100	700	0.47	2.7	26	D300130	A070UD30KI100	A070URD30KI0100
	125	700	0.85	4.9	30	E300131	A070UD30KI125	A070URD30KI0125
	160	700	1.6	9.2	37	F300132	A070UD30KI160	A070URD30KI0160
	200	700	3	16.7	43	G300133	A070UD30KI200	A070URD30KI0200
	250	700	5.8	32.4	50	H300134	A070UD30KI250	A070URD30KI0250
	315	700	12	67	55	J300135	A070UD30KI315	A070URD30KI0315
	350	700	15.5	86	60	K300136	A070UD30KI350	A070URD30KI0350
	400	700	23	130	65	L300137	A070UD30KI400	A070URD30KI0400
	450	700	26	165	88	T301064	A070UD30KI450	A070URD30KI0450
	500	700	41	264	88	V301065	A070UD30KI500	A070URD30KI0500
	550	700	52	330	90	W301066	A070UD30KI550	A070URD30KI0550
	31	200	700	2.6	14.6	45	S300028	A070UD31KI200
250		700	4.7	27	52	T300029	A070UD31KI250	A070URD31KI0250
315		700	7.5	43	65	V300030	A070UD31KI315	A070URD31KI0315
350		700	10.5	59	67	R300050	A070UD31KI350	A070URD31KI0350
400		700	19	110	68	W300031	A070UD31KI400	A070URD31KI0400
450		700	26.5	150	70	X300032	A070UD31KI450	A070URD31KI0450
500		700	37	210	72	Y300033	A070UD31KI500	A070URD31KI0500
550		700	52	300	75	Z300034	A070UD31KI550	A070URD31KI0550
630		700	75	421	85	A300035	A070UD31KI630	A070URD31KI0630
700		700	95	530	95	B300036	A070UD31KI700	A070URD31KI0700
800	700	140	880	120	A301070	A070UD31KI800	A070URD31KI0800	
32	400	700	15	86	75	Z300195	A070UD32KI400	A070URD32KI0400
	450	700	22	124	80	A300196	A070UD32KI450	A070URD32KI0450
	500	700	28	157	90	B300197	A070UD32KI500	A070URD32KI0500
	550	700	37	211	95	C300198	A070UD32KI550	A070URD32KI0550
	630	700	54	302	105	D300199	A070UD32KI630	A070URD32KI0630
	700	700	76	432	110	E300200	A070UD32KI700	A070URD32KI0700
	800	700	115	648	120	F300201	A070UD32KI800	A070URD32KI0800
	900	700	170	972	125	G300202	A070UD32KI900	A070URD32KI0900
	1000	700	240	1350	135	H300203	A070UD32KI1000	A070URD32KI1000
	33	500	700	19	108	105	W300238	A070UD33KI500
550		700	27	151	110	X300239	A070UD33KI550	A070URD33KI0550
630		700	40	227	120	Y300240	A070UD33KI630	A070URD33KI0630
700		700	55	324	125	Z300241	A070UD33KI700	A070URD33KI0700
800		700	95	529	130	A300242	A070UD33KI800	A070URD33KI0800
900		700	135	760	135	B300243	A070UD33KI900	A070URD33KI0900
1000		700	170	970	155	C300244	A070UD33KI1000	A070URD33KI1000
1100		700	240	1360	160	D300245	A070UD33KI1100	A070URD33KI1100
1250		700	350	2000	180	E300246	A070UD33KI1250	A070URD33KI1250
1400		700	480	2700	200	F300247	A070UD33KI1400	A070URD33KI1400
1600		650	555	3250	240	E302063	A065UD33KI1600	A065URD33KI1600

# 690/700 Volt PSC Square Body

## 700 Volt North American Style Ratings and Application Data, TTI Mounting

Body Size	Ampere Rating $I_n$ (A)	Rated Voltage $V_n$ (V)	Melting $I^2t$ ( $A^2s \times 10^3$ )	Total Clearing $I^2t$ @ $V_n$ ( $A^2s \times 10^3$ )	Watts Loss @ $I_n$ (W)	Reference No.	Catalog No.	Description
30	63	700	0.2	1.2	14	A301967	A070UD30TTI63	A070URD30TTI0063
	80	700	0.33	1.9	19	V301962	A070UD30TTI80	A070URD30TTI0080
	100	700	0.47	2.7	26	W300744	A070UD30TTI100	A070URD30TTI0100
	125	700	0.85	4.9	30	G300708	A070UD30TTI125	A070URD30TTI0125
	160	700	1.6	9.2	37	N300576	A070UD30TTI160	A070URD30TTI0160
	200	700	3	16.7	42	P300577	A070UD30TTI200	A070URD30TTI0200
	250	700	5.8	32.4	48	Q300578	A070UD30TTI250	A070URD30TTI0250
	315	700	12	67	53	R300579	A070UD30TTI315	A070URD30TTI0315
	350	700	15.5	86	57	S300580	A070UD30TTI350	A070URD30TTI0350
	400	700	23	130	60	T300581	A070UD30TTI400	A070URD30TTI0400
	450	700	26	165	80	V300582	A070UD30TTI450	A070URD30TTI0450
	500	700	41	264	80	W300583	A070UD30TTI500	A070URD30TTI0500
	550	700	52	330	80	X300584	A070UD30TTI550	A070URD30TTI0550
	31	200	700	2.6	14.6	45	A300472	A070UD31TTI200
250		700	4.7	27	52	B300473	A070UD31TTI250	A070URD31TTI0250
315		700	7.5	43	65	C300474	A070UD31TTI315	A070URD31TTI0315
350		700	10.5	59	67	D300475	A070UD31TTI350	A070URD31TTI0350
400		700	19	110	68	E300476	A070UD31TTI400	A070URD31TTI0400
450		700	26.5	150	70	F300477	A070UD31TTI450	A070URD31TTI0450
500		700	37	210	70	G300478	A070UD31TTI500	A070URD31TTI0500
550		700	52	300	70	H300479	A070UD31TTI550	A070URD31TTI0550
630		700	75	421	75	J300480	A070UD31TTI630	A070URD31TTI0630
700		700	95	530	85	K300481	A070UD31TTI700	A070URD31TTI0700
800	700	140	880	105	L300482	A070UD31TTI800	A070URD31TTI0800	
32	400	700	15	86	72	Q300463	A070UD32TTI400	A070URD32TTI0400
	450	700	22	124	77	N300461	A070UD32TTI450	A070URD32TTI0450
	500	700	28	157	85	P300462	A070UD32TTI500	A070URD32TTI0500
	550	700	37	211	90	R300464	A070UD32TTI550	A070URD32TTI0550
	630	700	54	302	95	S300465	A070UD32TTI630	A070URD32TTI0630
	700	700	76	432	100	T300466	A070UD32TTI700	A070URD32TTI0700
	800	700	115	648	110	V300467	A070UD32TTI800	A070URD32TTI0800
	900	700	170	972	110	W300468	A070UD32TTI900	A070URD32TTI0900
	1000	700	240	1350	115	X300469	A070UD32TTI1000	A070URD32TTI1000
	1100	650	270	1620	140	M301081	A065UD32TTI1100	A065URD32TTI1100
	1250	600	410	2100	150	N301082	A060UD32TTI1250	A060URD32TTI1250
	1400	550	555	2600	160	P301083	A055UD32TTI1400	A055URD32TTI1400
	1600	550	870	4000	165	Q301084	A055UD32TTI1600	A055URD32TTI1600
	1800	500	1050	4400	195	R301085	A050UD32TTI1800	A050URD32TTI1800
33	500	700	19	108	105	X300446	A070UD33TTI500	A070URD33TTI0500
	550	700	27	151	105	Y300447	A070UD33TTI550	A070URD33TTI0550
	630	700	40	227	110	Z300448	A070UD33TTI630	A070URD33TTI0630
	700	700	55	324	115	A300449	A070UD33TTI700	A070URD33TTI0700
	800	700	95	529	120	T300443	A070UD33TTI800	A070URD33TTI0800
	900	700	135	760	120	B300450	A070UD33TTI900	A070URD33TTI0900
	1000	700	170	970	135	C300451	A070UD33TTI1000	A070URD33TTI1000
	1100	700	240	1360	135	D300452	A070UD33TTI1100	A070URD33TTI1100
	1250	700	350	2000	150	E300453	A070UD33TTI1250	A070URD33TTI1250
	1400	700	480	2700	160	F300454	A070UD33TTI1400	A070URD33TTI1400
	1600	650	555	3250	210	S301086	A065UD33TTI1600	A065URD33TTI1600
	1800	650	720	4330	225	T301087	A065UD33TTI1800	A065URD33TTI1800
	2000	600	950	5000	250	V301088	A060UD33TTI2000	A060URD33TTI2000
	2250	550	1250	5900	280	W301089	A055UD33TTI2250	A055URD33TTI2250
	2500	500	1870	7600	280	Y300838	A050UD33TTI2500	A050URD33TTI2500

For the most current product performance data visit [ep-us.mersen.com](http://ep-us.mersen.com) and use catalog search.

# 690/700 Volt PSC Square Body

## 690/700 Volt, 2x32, 2x33 Protection Semiconductor Fuses

Size	Reference No.	Catalog No.	Description	Weight (g)
2 X 32	T300213	PC232UD69V10CTF	6,9URD232TTF1000	1240
	V300214	PC232UD69V13CTF	6,9URD232TTF1250	
	G300087	PC232UD69V14CTF	6,9URD232TTF1400	
	W300215	PC232UD69V16CTD	6,9URD232TDF1600	3300
	X300216	PC232UD69V18CTD	6,9URD232TDF1800	
	Y300217	PC232UD69V20CTD	6,9URD232TDF2000	
2 X 33	D301993	PC232UD55V22CTD	5,5URD232TDF2200	1900
	D300268	PC233UD66V13CTF	6,6URD233TTF1250	
	E300269	PC233UD66V14CTF	6,6URD233TTF1400	
	F300270	PC233UD66V16CTF	6,6URD233TTF1600	2000
	B300427	PC36UD69V18CP11	6,9URD233PLAF1800	
	R302235	PC36UD60V20CP11	6URD233PLAF2000	
	Q302234	PC36UD60V22CP11	6URD233PLAF2200	
	P302233	PC36UD60V25CP11	6URD233PLAF2500	
	N302232	PC36UD60V28CP11	6URD233PLAF2800	
	L301977	PC36UD55V30CP11	5,5URD233PLAF3000	
	M301978	PC36UD55V32CP11	5,5URD233PLAF3200	
	N301979	PC36UD50V36CP11	5URD233PLAF3600	
	P301980	PC36UD50V40CP11	5URD233PLAF4000	
	Q301981	PC36UD45V45CP11	4,5URD233PLAF4500	
R301982	PC36UD40V50CP11	4URD233PLAF5000		

## Dimensions (mm)

Size	A	B	C	D	E	F	G	H	J	K	d	e	L	M	N
2x32 TT	60	138.5	172	11	67.6	66.5	100	35	61	40	M 10	4	107.5	48	72
2x33 TT	74.4	167	200	13	67.6	81	114	50	80	40	M 12	4	107.5	54	86
2x32 TD	65.5	147	182	-	91.5	-	-	30	-	60	M 10	12	140	-	-
2x33 PLAF	75	171.5	207	-	55.5	-	115	40	-	71	M 10	15	81	-	-

