

Monitoring relay

70
SERIES



Air
conditioners



Wood-
processing
machines



Hoists and
cranes



Escalators



Control panels
for pumps



Forced-air
ventilators



Electronic voltage monitoring relays for single and three-phase applications

- Multifunctional types, providing the flexibility of monitoring Undervoltage, Overvoltage, Window Mode, Phase rotation, Phase loss
- Positive safety logic - Make output contact opens if the relay detects an error
- All functions and values can be easily adjusted by the selector and trimmer on front face
- "Blade + cross" – both flat blade and cross head screw drivers can be used to adjust the regulators and the function selector
- Colored LEDs for clear & immediate visual indication
- 1 CO relay output, 6 or 10 A
- Modular housing, 17.5 or 35 mm wide
- 35 mm rail (EN 60715) mount
- Cd-free contact material

Screw terminal



For outline drawing see page 15

Contact specification

Contact configuration		1 CO (SPDT)	1 CO (SPDT)
Rated current/Maximum peak current	A	10/30	6/10
Rated voltage/ Max. switching voltage	V AC	250/400	250/400
Rated load AC1	VA	2500	1500
Rated load AC15	VA	750	500
Single phase motor rating (230 V AC)	kW	0.5	0.185
Breaking capacity DC1: 30/110/220 V	A	10/0.3/0.12	6/0.2/0.12
Minimum switching load	mW (V/mA)	300 (5/5)	500 (12/10)
Standard contact material		AgNi	AgNi

Supply specification

Nominal system voltage (U _N)	V AC (50/60 Hz)	220...240	380...415
Rated power	VA (50 Hz)/W	2.6/0.8	11/0.9
Operating range	V AC (50/60 Hz)	130...280	220...510

Technical data

Electrical life at rated load AC1	cycles	80 · 10 ³	60 · 10 ³
Voltage detection level range	V	170...270	300...480
Asymmetry detection level range	%	—	—
Switch-off delay time (T on function diagrams)	s	0.5...60	0.5...60
Switch-on lock-out time	s	0.5	1
Switch-on hysteresis (H on function diagrams)	V	5 (L-N)	10 (L-L)
Power-on activation time	s	≈ 1	≈ 1
Insulation between supply and contacts (1.2/50 μs)	kV	4	4
Dielectric strength between open contacts	V AC	1000	1000
Ambient temperature	°C	-20...+60	-20...+60
Protection category		IP 20	IP 20

Approvals (according to type)



70.11



Single-phase (220...240)V
voltage monitoring:

- Undervoltage
- Overvoltage
- Window mode (overvoltage + undervoltage)
- Voltage fault memory selectable

70.31



Three-phase (380...415)V
voltage monitoring:

- Undervoltage
- Overvoltage
- Window mode (overvoltage + undervoltage)
- Voltage fault memory selectable
- Phase loss, even under phase regeneration
- Phase rotation

Electronic voltage monitoring relays for three-phase applications

- Multifunctional types, providing the flexibility of monitoring Undervoltage, Overvoltage, Window Mode, Phase rotation, Phase loss, Asymmetry and Neutral loss
- Phase loss monitoring, even under phase regeneration
- Positive safety logic - Make output contact opens if the relay detects an error
- All functions and values can be easily adjusted by the selector and trimmer on front face
- "Blade + cross" – both flat blade and cross head screw drivers can be used to adjust the regulators and the function selector
- Colored LEDs for clear & immediate visual indication
- 1 or 2 CO relay output, 6 or 8 A
- Modular housing, 35 mm wide
- 35 mm rail (EN 60715) mount
- Cd-free contact material

Screw terminal



For outline drawing see page 15

Contact specification

		70.41	70.42
Contact configuration		1 CO (SPDT)	2 CO (DPDT)
Rated current/Maximum peak current	A	6/10	8/15
Rated voltage/ Max. switching voltage	V AC	250/400	250/400
Rated load AC1	VA	1500	2000
Rated load AC15	VA	500	400
Single phase motor rating (230 V AC)	kW	0.185	0.3
Breaking capacity DC1: 30/110/220 V	A	6/0.2/0.12	8/0.3/0.12
Minimum switching load	mW (V/mA)	500 (12/10)	300 (5/5)
Standard contact material		AgNi	AgNi

Supply specification

		70.41	70.42
Nominal system voltage (U_N)	V AC (50/60 Hz)	380...415	380...415
Rated power	VA (50 Hz)/W	11/0.9	12.5/1
Operating range	V AC (50/60 Hz)	220...510	220...510

Technical data

		70.41	70.42
Electrical life at rated load AC1	cycles	$60 \cdot 10^3$	$60 \cdot 10^3$
Voltage detection level range	V	300...480	300...480
Asymmetry detection level range	%	4...25	5...25
Switch-off delay time (T on function diagrams)	s	0.5...60	0.5...60
Switch-on lock-out time	s	1	1
Switch-on hysteresis (H on function diagrams)	V	10 (L-L)	10 (L-L)
Power-on activation time	s	≈ 1	≈ 1
Insulation between supply and contacts (1.2/50 μ s)	kV	4	4
Dielectric strength between open contacts	V AC	1000	1000
Ambient temperature	$^{\circ}$ C	-20...+60	-20...+60
Protection category		IP 20	IP 20

Approvals (according to type)

70.41

Three-phase (380...415 V, with or without neutral) voltage monitoring:

- Window mode (overvoltage + undervoltage)
- Phase loss
- Phase rotation
- Asymmetry
- Neutral loss selectable

70.42

Three-phase (380...415 V, with neutral) voltage monitoring:

- Undervoltage
- Overvoltage
- Window mode (overvoltage + undervoltage)
- Voltage fault memory selectable
- Phase loss
- Phase rotation
- Asymmetry
- Neutral loss

Universal current detecting and monitoring relay

- Multifunctional type, providing the flexibility of monitoring Undercurrent, Overcurrent and Window Mode
- Positive safety logic - Make output contact opens if the relay detects an error
- All functions and values can be easily adjusted by the selector and trimmer on front face
- "Blade + cross" –both flat blade and cross head screw drivers can be used to adjust the regulators and the function selector
- Colored LED for clear & immediate visual indication
- 1 CO 10 A relay output
- Modular housing, 35 mm wide

Screw Terminal



For outline drawing see page 15

NEW 70.51.0.240.2032



- 6 Functions universal current monitoring relay
- AC/DC current detection 50 mA...16 A
- Fault memory selectable
- Switch-on hysteresis (5...50)% (1...99% in Window Mode)

Contact specification

Contact configuration		1 CO (SPDT)
Rated current/Maximum peak current	A	10/15
Rated voltage/ Maximum switching voltage	V AC	250/400
Rated load AC1	VA	2500
Rated load AC15 (230 V AC)	VA	500
Single phase motor rating (230 V AC)	kW	0.5
Breaking capacity DC1: 30/110/220 V	A	10/0.3/0.12
Minimum switching load	mW (V/mA)	300 (5/5)
Standard contact material		AgSnO ₂

Supply specification

Nominal voltage (U _N)	V AC (50/60 Hz)	24...240
	V DC	24...240
Rated power AC/DC	VA (50 Hz)/W	2.5/0.53
Operating range	AC	(0.8...1.1)U _N
	DC	(0.8...1.1)U _N

Technical data

Electrical life at rated load AC1	cycles	100 · 10 ³
Detection levels	AC(50/60 Hz)/DC	50 mA...16 A
Switch-off delay time (T ₂ on function diagrams)	s	0.1...30
Switch-on hysteresis (H on function diagrams)	%	5...50 (1...99 in Window Mode)
Switch-on lock-out time	s	0.1...40
Electrical isolation: Supply to Measuring circuits		Yes
Ambient temperature range	°C	-20...+55
Protection category		IP 20

Approvals (according to type)



Electronic phase loss and rotation monitoring relays for three-phase applications

- Universal voltage monitoring (U_N from 208 V to 480 V, 50/60 Hz)
- Phase loss monitoring, even under phase regeneration
- Positive safety logic - Make contact opens if the relay detects an error
- 2 versions:
 - 1 CO relay output, 6 A (17.5 mm wide), and
 - 2 CO relay output, 8 A (22.5 mm wide)
- 35 mm rail (EN 60715) mount
- European patent pending for the innovative principle at the root of the 3 phase monitoring and error survey system (70.61)

70.61
Screw terminal70.61-P000
Push-in terminal
NEW 70.61/70.61-P000

 Three-phase (208...480)V
voltage monitoring:

- Phase loss
- Phase rotation

70.62

 Three-phase (208...480)V
voltage monitoring:

- Phase loss
- Phase rotation

For outline drawing see page 16

Contact specification

		1 CO (SPDT)	2 CO (DPDT)
Contact configuration		1 CO (SPDT)	2 CO (DPDT)
Rated current/Maximum peak current	A	6/15	8/15
Rated voltage/ Max. switching voltage	V AC	250/400	250/400
Rated load AC1	VA	1500	2000
Rated load AC15	VA	250	400
Single phase motor rating (230 V AC)	kW	0.185	0.3
Breaking capacity DC1: 30/110/220 V	A	3/0.35/0.2	8/0.3/0.12
Minimum switching load	mW (V/mA)	500 (10/5)	300 (5/5)
Standard contact material		AgSnO ₂	AgNi

Supply specification

Nominal system voltage (U_N)	V AC (50/60 Hz)	208...480	208...480
Rated power	VA (50 Hz)/W	8/1	11/0.8
Operating range	V AC (50/60 Hz)	170...500	170...520

Technical data

Electrical life at rated load AC1	cycles	$100 \cdot 10^3$	$60 \cdot 10^3$
Switch-off delay time	s	0.5	0.5
Switch-on lock-out time	s	0.5	0.5
Power-on activation time	s	< 2	< 2
Insulation between supply and contacts (1.2/50 μ s)	kV	5	5
Dielectric strength between open contacts	V AC	1000	1000
Ambient temperature	°C	-20...+60	-20...+60
Protection category		IP 20	IP 20

Approvals (according to type)

Ordering information

Example: 70 series, three-phase voltage monitoring relay, 1 output, supply voltage 380...415 V AC.



Series

Type

- 1 = 1 phase AC line monitoring
- 3 = 3 phase AC line monitoring
- 4 = 3 phase + neutral AC line monitoring
- 5 = AC/DC universal- Current detection
- 6 = 3 phase loss and rotation monitoring

No. of poles

- 1 = 1 pole
- 2 = 2 pole

Supply version

- 0 = AC (50/60 Hz)/DC
- 8 = AC (50/60 Hz)

Supply voltage

- 230 = 220...240 V (70.11)
- 240 = 240 V AC/DC (70.51)
- 400 = 380...415 V (70.31/41/42)
- 400 = 208...480 V (70.61/62)

D: Fault memory option

- 0 = No fault memory
- 2 = Fault memory function selectable

C: Time delay setting

- 0 = Fixed switch-off delay
- 2 = Adjustable switch-off delay
- 3 = Adjustable switch-off delay and asymmetry (for 70.41 and 70.42 only)
Adjustable switch-off and switch-on delay (for 70.51 only)

B: Contact circuit

- 0 = CO (nPDT)

A: Detection Values / Terminals options

- 0 = Non-adjustable detection values
- 2 = 2 adjustable detection values
- P = Push-in terminals (70.61 only)

Codes

70.11.8.230.2022	70.51.0.240.2032
70.31.8.400.2022	70.61.8.400.0000
70.41.8.400.2030	70.61.8.400.P000
70.42.8.400.2032	70.62.8.400.0000

Selection guide

Type	70.11.8.230.2022	70.31.8.400.2022	70.41.8.400.2030	70.42.8.400.2032	70.51.0.240.2032	70.61.8.400.P000	70.62.8.400.0000
Supply system type	Single phase	3-phase	3-phase/ 3-phase + neutral	3-phase + neutral	Single phase	3-phase	3-phase
Functions							
Undervoltage/Overvoltage	AC	AC	—	AC	—	—	—
Window mode (Undervoltage and Overvoltage)	AC	AC	AC	AC	—	—	—
Phase loss	—	•	•	•	—	•	•
Phase rotation	—	•	•	•	—	•	•
Asimmetry	—	—	•	•	—	—	—
Neutral loss	—	—	•	•	—	—	—
Overcurrent/Undercurrent	—	—	—	—	•	—	—
Window mode (Undercurrent and Overcurrent)	—	—	—	—	•	—	—
Thermistor relay (PTC)	—	—	—	—	—	—	—
Delay Times							
Fixed	—	—	—	—	—	•	•
Adjustable	•	•	•	•	•	—	—
Supply voltage							
24 V AC/DC	—	—	—	—	—	—	—
24...240 V AC/DC	—	—	—	—	•	—	—
230 V AC	•	—	—	—	—	—	—
400 V AC	—	•	•	•	—	•	•
Module width							
35 mm wide	—	•	•	•	•	—	—
22.5 mm wide	—	—	—	—	—	—	•
17.5 mm wide	•	—	—	—	—	•	—
Other data							
Fault memory	•	•	—	•	•	—	—
Contact configuration	1 CO	1 CO	1 CO	2 CO	1 CO	1 CO	2 CO

Technical data

Insulation			70.11/31/41/42	70.51	70.61	70.62
Between supply and contacts	dielectric strength	V AC	2500	2500	2500	3000
	impulse (1.2/50 µs)	kV	4	4	5	5
Between open contacts	dielectric strength	V AC	1000	1000	1000	1000
	impulse (1.2/50 µs)	kV	1.5	1.5	1.5	1.5
EMC specifications						
Type of test			Reference standard			
Electrostatic discharge	contact discharge		EN 61000-4-2		4 kV	
	air discharge		EN 61000-4-2		8 kV	
Radiated electromagnetic field	80...1000 MHz		EN 61000-4-3		10 V/m	
	1...2.8 GHz		EN 61000-4-3		5 V/m	
Fast transients (burst 5/50 ns, 5 and 100 kHz)	on supply terminals		EN 61000-4-4		4 kV	
Voltage pulses on supply terminals (surge 1.2/50 µs)	common mode		EN 61000-4-5		4 kV	
	differential mode		EN 61000-4-5		4 kV	
Radiofrequency common mode voltage (0.15...230 MHz)	on supply terminals		EN 61000-4-6		10 V	
Voltage dips	70% U _N		EN 61000-4-11		25 cycles	
Short interruptions			EN 61000-4-11		1 cycle	
Radiofrequency conducted emissions	0.15...30 MHz		CISPR 11		class B	
Radiated emissions	30...1000 MHz		CISPR 11		class B	
Terminals			Screw terminals		Push-in terminals	
Wire strip length	mm		10		10	
 Screw torque	Nm		0.8		—	
Min. wire size			Solid cable		Solid cable	
	mm ²		0.5		0.75	
	AWG		20		18	
Max. wire size			Solid cable		Solid cable	
	mm ²		1 x 6 / 2 x 4		1 x 1.5 / 2 x 1.5	
	AWG		1 x 10 / 2 x 12		1 x 16 / 2 x 16	
Min. wire size			Stranded cable		Stranded cable	
	mm ²		0.5		0.75	
	AWG		20		18	
Max. wire size			Stranded cable		Stranded cable	
	mm ²		1 x 4 / 2 x 2.5		1 x 2.5 / 2 x 2.5	
	AWG		1 x 12 / 2 x 14		1 x 14 / 2 x 14	
Other data			70.11	70.31/41	70.42/61/62	70.51
Power lost to the environment	without output current	W	0.8	0.9	1	2 (230 V AC) / 0.2 (24 V DC)
	with rated output current	W	2	1.2	1.4	2.5 (230 V AC) / 0.5 (24 V DC)

Functions

Output relay On (NO closed) when all OK: positive logic.

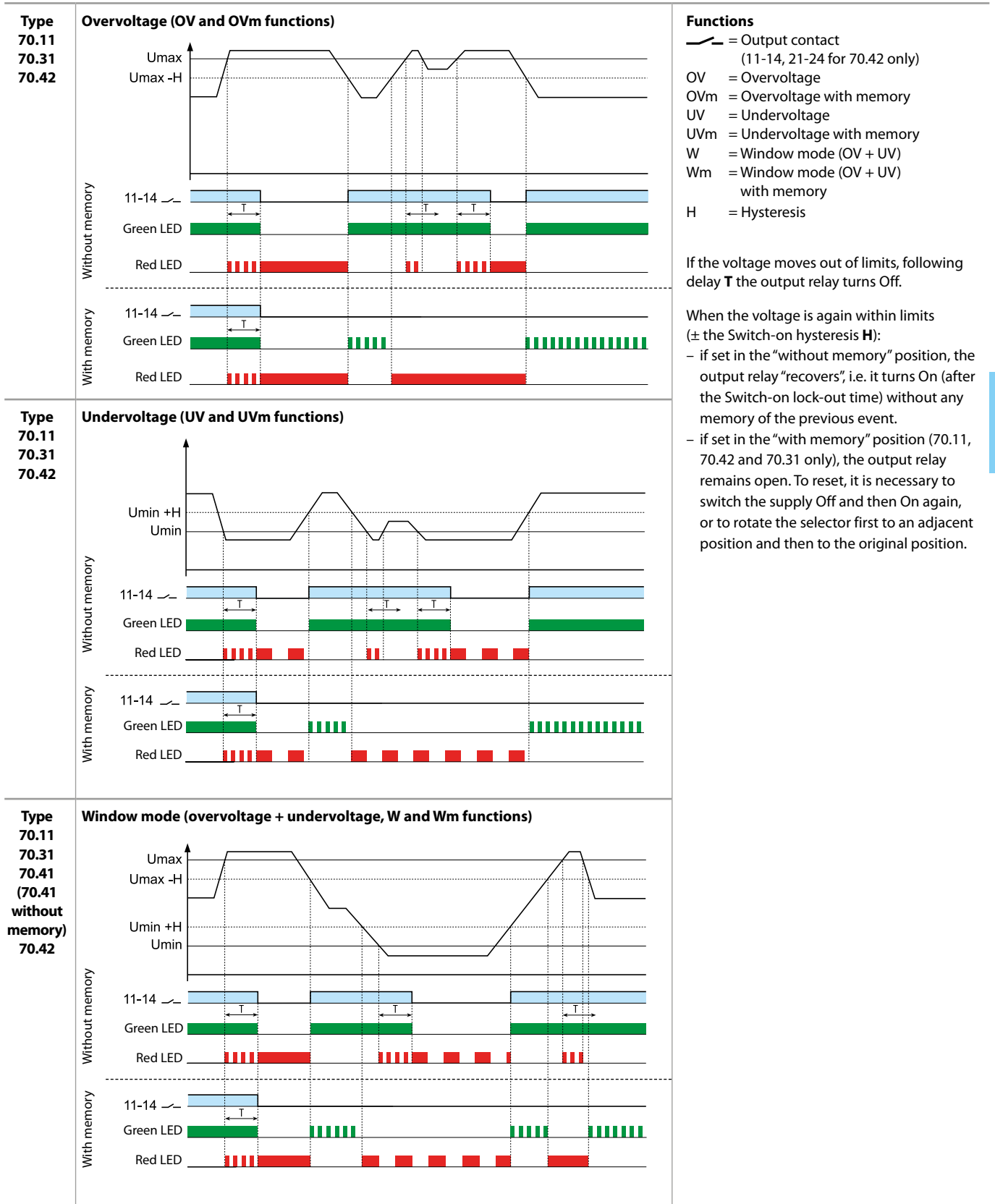

Functions

Output relay On (NO closed) when all OK: positive logic.

<p>Type 70.31 70.41 70.42 70.61 70.62</p>	<p>Phase loss and phase rotation</p>	<p>If the sequence (L1, L2, L3) is incorrect at power-on, the output relay will not turn-on.</p> <p>If a phase is lost, the output relay turns off immediately. When the phase is again active, the output relay turns on immediately.</p> <p>Phase loss monitoring possible even under regeneration up to 80% of the average of the other 2 phases.</p>
<p>E Type 70.41 70.42</p>	<p>Neutral loss and asymmetry</p>	<p>If the neutral is lost (and the Neutral control function is set), the output relay turns off immediately. When the neutral is again present, the output relay turns on immediately.</p> <p>If the asymmetry $(U_{max} - U_{min})/U_N$ is above the % set value, the output relay turns off after the set delay T. When the asymmetry is again below the % set value (with a fixed hysteresis of approximately 2%), the output relay turns on after the Switch-on lock-out time.</p>

Functions

Output relay On (NO closed) when all OK: positive logic.

Type
70.51

Overcurrent (OC and OCm functions)

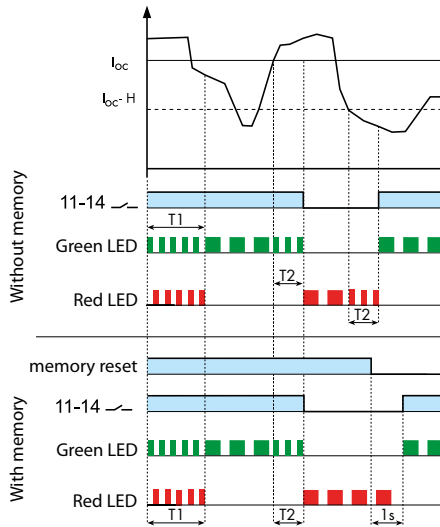

Functions

- = Output contact 11-14
- OC = Overcurrent
- OCm = Overcurrent with memory
- UC = Undercurrent
- UCm = Undercurrent with memory
- W = Window mode (OC + UC)
- Wm = Window mode (OC + UC) with memory
- H = Hysteresis

If the current moves out of limits, following delay **T2** the output relay turns Off.

When the current is again within limits the Switch-on hysteresis **H**:

- if set in the "without memory" position, the output relay "recovers", i.e. it turns On (after the Switch-on lock-out time) without any memory of the previous event;
- if set in the "with memory" position the output relay remains open.

Undercurrent (UC and UCm functions)

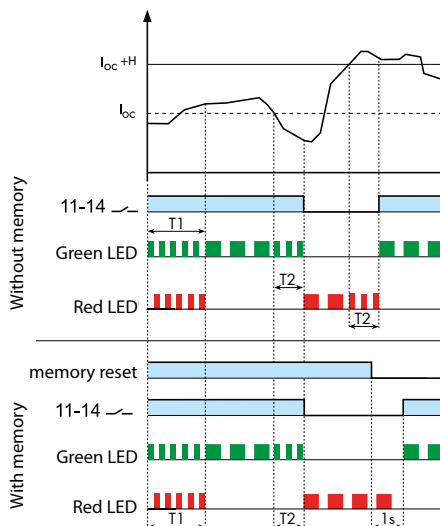

To reset, it is necessary to switch the supply Off and then On again, or to push button connected on RESET terminals.

During **T1** delay the relay don't monitoring.

Window Mode (Overcurrent + Undercurrent, W and Wm functions)

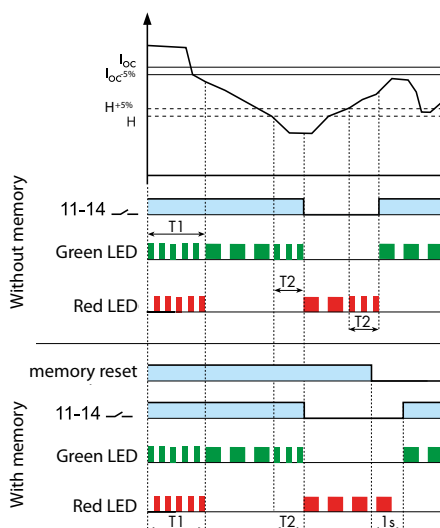

Front view: function selector and regulators

<p>70.11</p> <p>Functions: OV, OVm, UV, UVm, W, Wm</p> <p>Toff delay: (0.5...60)sec</p> <p>U_{Max}: (220...270)V</p> <p>U_{Min}: (170...230)V</p>	<p>70.31</p> <p>Functions: OV, OVm, UV, UVm, W, Wm</p> <p>U_{Max}: (380...480)V</p> <p>U_{Min}: (300...400)V</p> <p>Toff delay: (0.5...60) sec</p> <p>U_{Min}: (300...400)V</p>	<p>70.41</p> <p>N= With N-line monitoring N≠ Without N-line monitoring</p> <p>U_{Max}: (380...480)V</p> <p>(4...25)% U_N</p> <p>U_{Min}: (300...400)V</p> <p>Toff delay: (0.5...60)sec</p>
----------------------------------------------------------------------------------------------------------------------------------------------------------------------------------------------	----------------------------------------------------------------------------------------------------------------------------------------------------------------------------------------------------------------------------------------	-----------------------------------------------------------------------------------------------------------------------------------------------------------------------------------------------------------------------------------------------------

E

70.42

Functions:
OV, OVm, UV,
UVm, W, Wm

U_{Max}:
(380...480)V

(5...25)% U_N

U_{Min}:
(300...400)V

Toff delay:
(0.5...60)sec

70.51

Detection levels I_M:
(0.5, 1, 2, 5, 10, 16) A

Functions:
OC, OCm, UC,
UCm, W, Wm

Current value
(0...I_M)

Switch on lock out time
(0.1...40 sec)

Switch OFF Delay
(0.1...30 sec)

Hysteresys
5...50%
1...99% in Window Mode

LED indication

Monitoring relay Type	LED	Supply system normal	Supply system abnormal (Voltage out of limits, switch-off delay time T running)	Supply system abnormal (Reason for switch-off, RESET necessary when "with Memory"* is selected)
		Contact 11 - 14 closed	Contact 11 - 14 closed	Contact 11-14 open
70.11.8.230.2022	• •		 	Overvoltage OV and OVm Undervoltage UV and UVm With Memory, following a failure a manual "RESET" ** is necessary
70.31.8.400.2022	• • •		 	Overvoltage OV and OVm Undervoltage UV and UVm Phase loss Phase rotation With Memory, following a failure a manual "RESET" ** is necessary
70.41.8.400.2030	• • •		 	Overvoltage OV Undervoltage UV Asymmetry Phase loss Neutral loss Phase rotation
70.42.8.400.2032	• • •		 	Overvoltage OV and OVm Undervoltage UV and UVm Asymmetry Phase loss Neutral loss Phase rotation With Memory, following a failure a manual "RESET" ** is necessary
70.51.0.240.2032	• •		or (during T2 time) (during T1 time)	or (during T2 time)
70.61.8.400.x000	•			Phase rotation or Phase loss
70.62.8.400.0000	•			Phase loss Phase rotation

* The function "with Memory" is only available for type 70.11, 70.31, 70.42 and 70.51.

** It is necessary to switch the supply OFF and then On again (U off U on) or to rotate the function selector first to an adjacent position and then to the original position.

Wiring diagrams

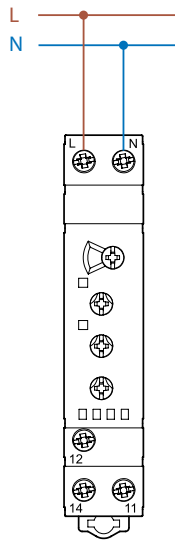

Type 70.11

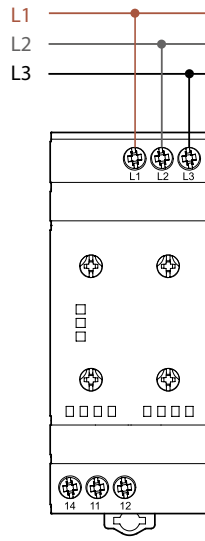

Type 70.31

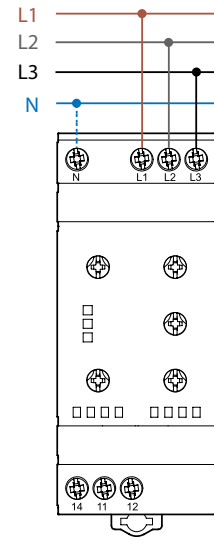

Type 70.41

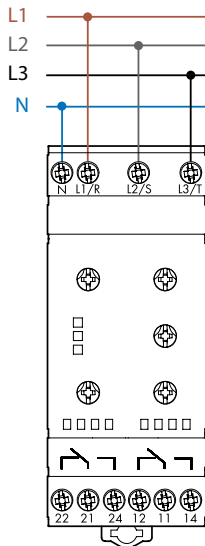

Type 70.42

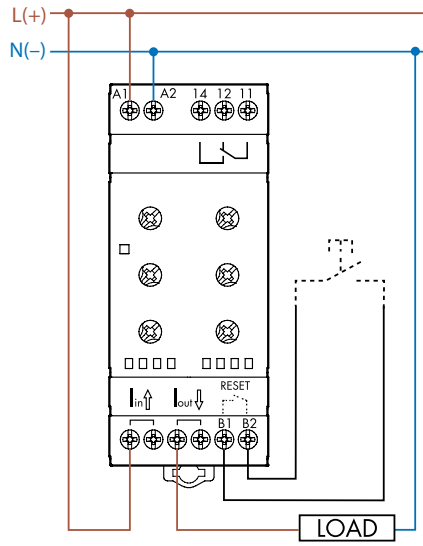

Type 70.51

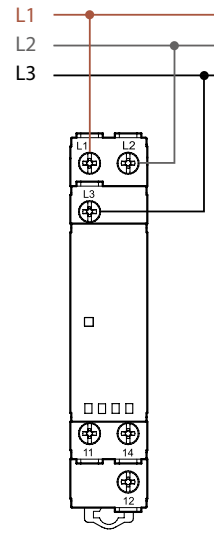

Type 70.61

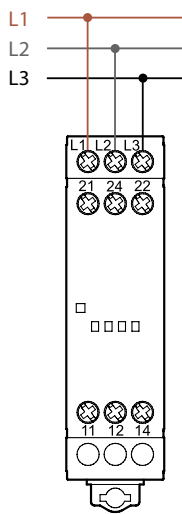

Type 70.62

Application example

The output contact switches the coil of the line contactor.

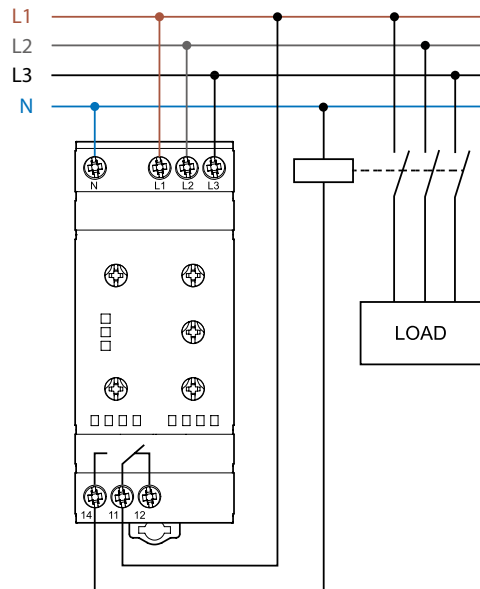

Outline drawings

Type 70.11
Screw terminal

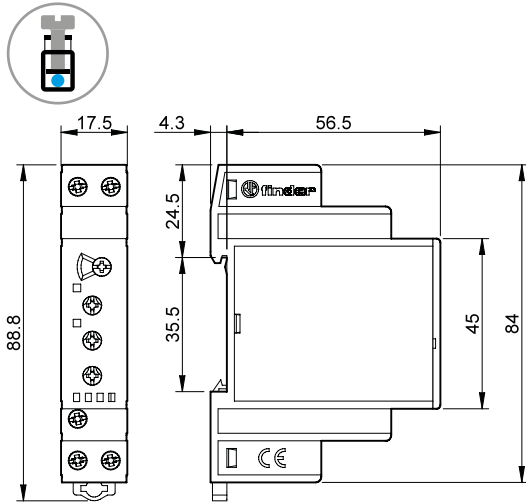

Type 70.31
Screw terminal

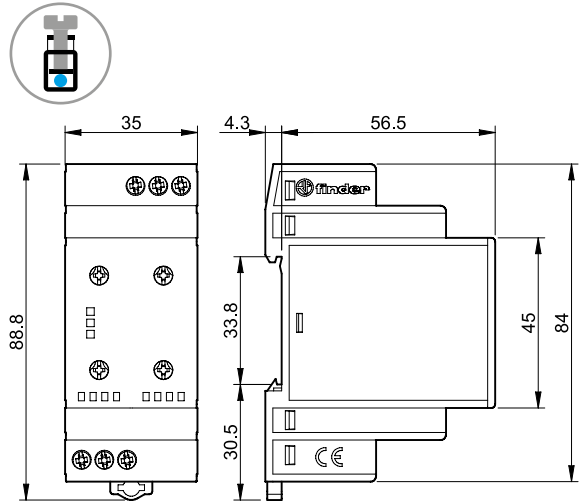

Type 70.41
Screw terminal

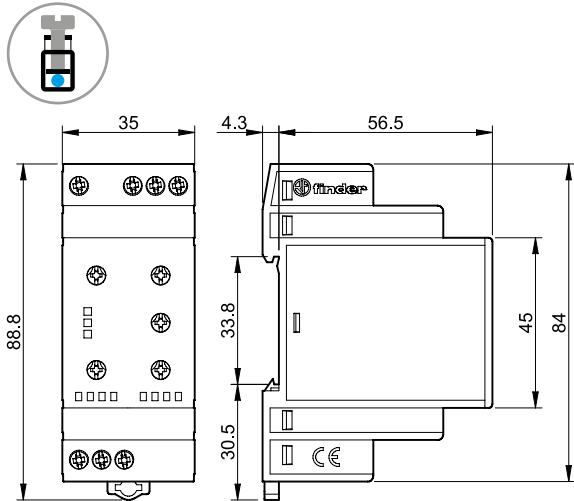

Type 70.42
Screw terminal

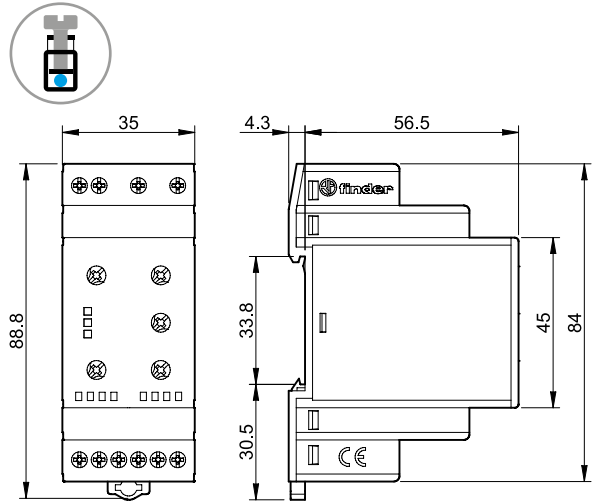

Type 70.51
Screw terminal

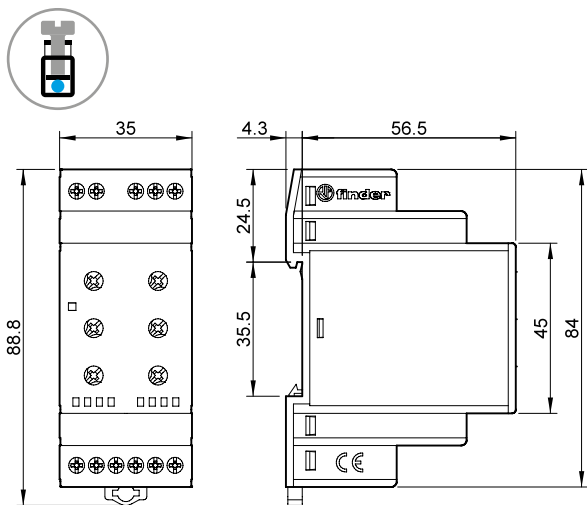

Type 70.61
Screw terminal

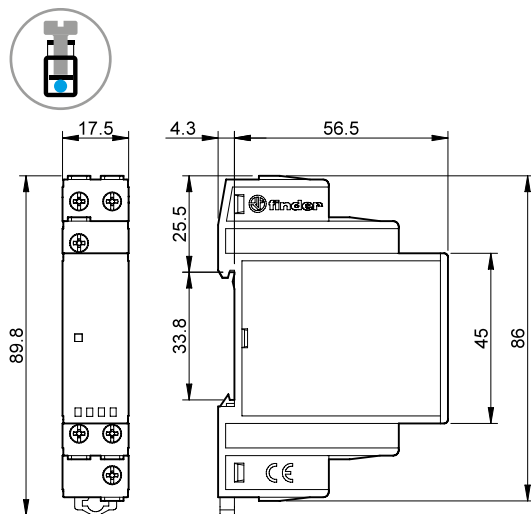

Outline drawings

Type 70.61-P000
Push-in terminal

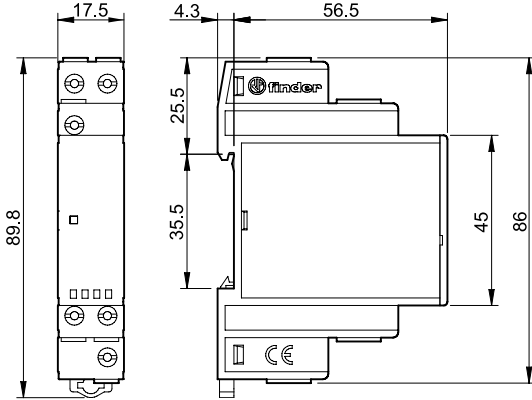

Type 70.62
Screw terminal

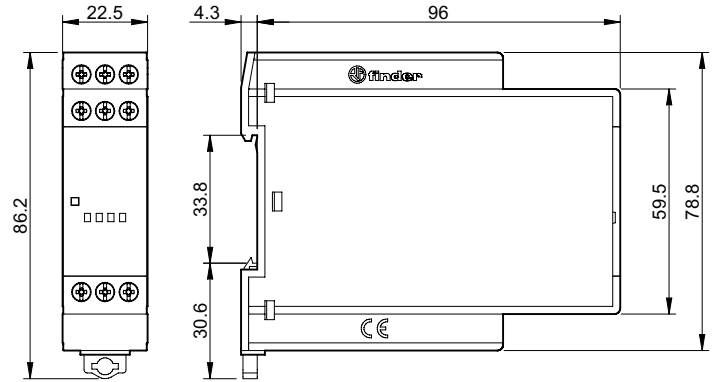

E Accessories



020.01

Adaptor for panel mounting, plastic, 17.5 mm wide for 70.11 and 70.61

020.01

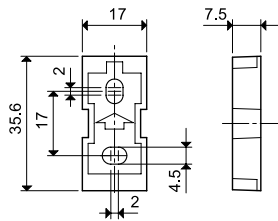

011.01

Adaptor for panel mounting, plastic, 35 mm wide for 70.31, 70.41, 70.42 and 70.51

011.01

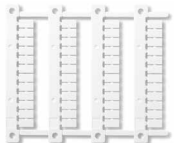
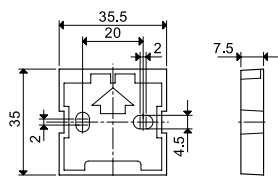

060.48

Sheet of marker tags (CEMBRE Thermal transfer printers) for relays types 70.11, 70.31, 70.41, 70.42, 70.51 and 70.62 (48 tags), 6 x 12 mm

060.48



019.01

Identification tag, plastic, 1 tag, 17 x 25.5 mm for 70.11, 70.31, 70.41, 70.42 and 70.51

019.01

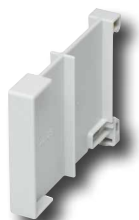

022.09

Separator for rail mounting, plastic, 9 mm wide

022.09

