

SPECIFICATION

Device Name : IGBT - IPM

Type Name : 7MBP50RU2A120

Spec. No. : MS6M01051

This material and the information herein is the property of Fuji Electric Device Technology Co., Ltd. They shall be neither reproduced, copied, lent, or disclosed in any way whatsoever for the use of any third party nor used for the manufacturing purposes without the express written consent of Fuji Electric Device Technology Co., Ltd.

	DATE	NAME	APPROVED	Fuji Electric Device Technology Co., Ltd.		
DRAWN	Jan. - 5 - '06	<i>N. Matsuda</i>		DWG. NO	MS6M01051	1 / 23
CHECKED	Jan - 5 - '06	<i>M. Watanabe</i>				
CHECKED	- -	<i>K. Yamada</i>	<i>T. Ogasawara</i>			

1. Package Outline Drawings

Package type : P611

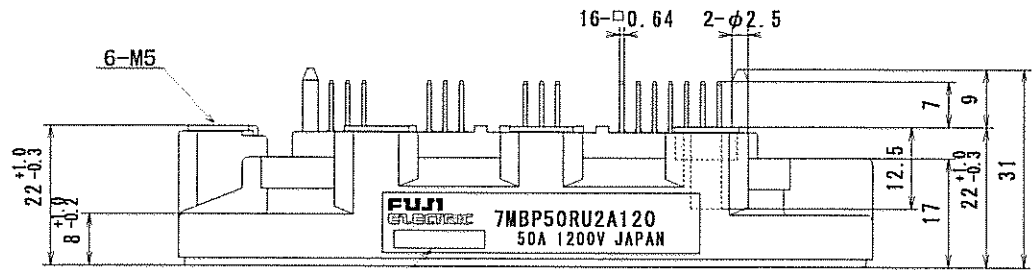
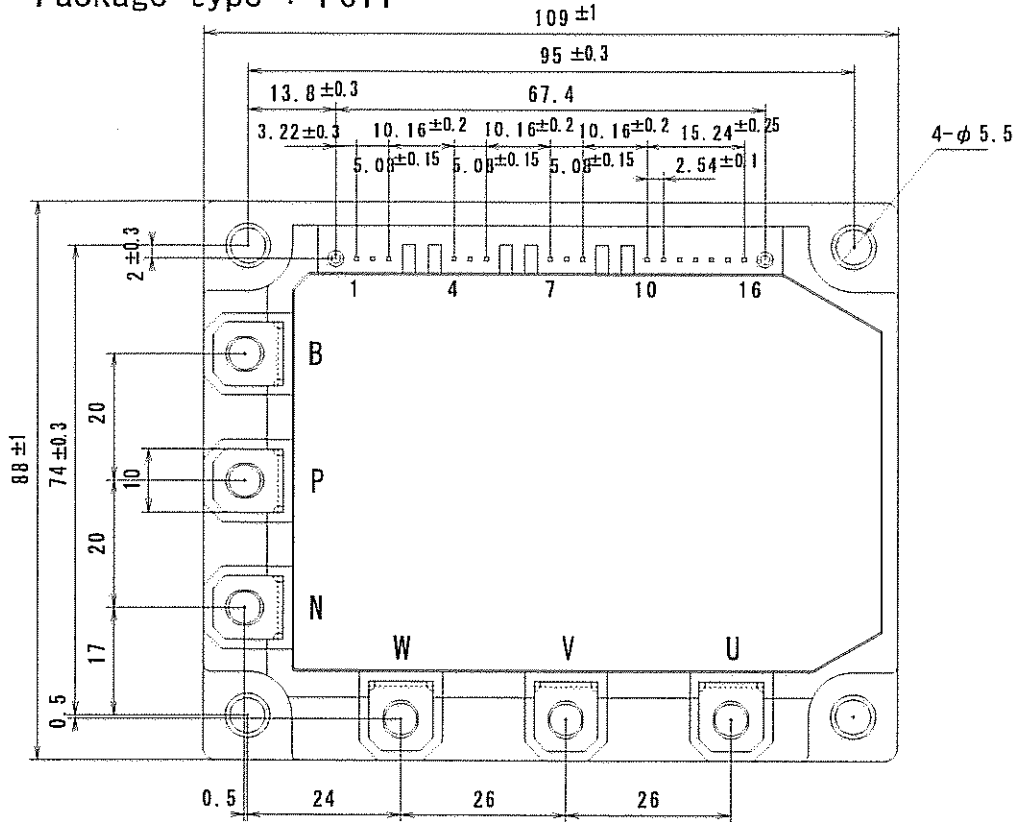

Indication of Lot No.

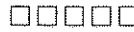

Ordered No. in monthly
 Manufactured month
 (Jan. ~ Sep. : 1~9, Oct. : 0, Nov. : N, Dec. : D)
 Last digit of manufactured year

3.22 ± 0.3 2.54 ± 0.1 2.54 ± 0.1

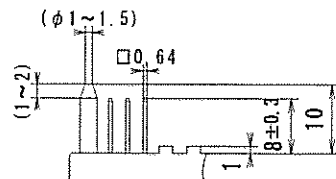
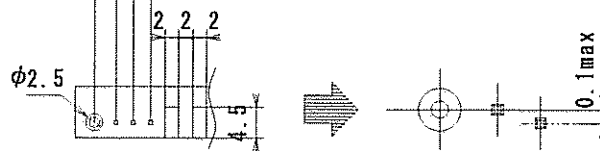

Details of control terminals

Dimensions in mm

Fuji Electric Device Technology Co., Ltd.

DWG. NO.

MS6M 01051

3

23

H04-004-03a

This material and the information herein is the property of Fuji Electric Device Technology Co., Ltd. They shall be neither reproduced, copied, lent, or disclosed in any way whatsoever for the use of any third party nor used for the manufacturing purposes without the express written consent of Fuji Electric Device Technology Co., Ltd.

2. Pin Descriptions

2.1 Main circuit

Symbol	Description
U	Output (U).
V	Output (V).
W	Output (W).
N	Negative input supply voltage.
P	Positive input supply voltage.
B	Collector terminal of Brake IGBT.

2.2 Control circuit

No	Symbol	Description
①	GNDU	High side ground (U).
②	VinU	Logic input for IGBT gate drive (U).
③	VccU	High side supply voltage (U).
④	GNDV	High side ground (V).
⑤	VinV	Logic input for IGBT gate drive (V).
⑥	VccV	High side supply voltage (V).
⑦	GNDW	High side ground (W).
⑧	VinW	Logic input for IGBT gate drive (W).
⑨	VccW	High side supply voltage (W).
⑩	GND	Low side ground.
⑪	Vcc	Low side supply voltage.
⑫	VinDB	Logic input for Brake IGBT gate drive.
⑬	VinX	Logic input for IGBT gate drive (X).
⑭	VinY	Logic input for IGBT gate drive (Y).
⑮	VinZ	Logic input for IGBT gate drive (Z).
⑯	ALM	Low side alarm signal output.

This material and the information herein is the property of Fuji Electric Device Technology Co., Ltd. They shall be neither reproduced, copied, lent, or disclosed in any way whatsoever for the use of any third party nor used for the manufacturing purposes without the express written consent of Fuji Electric Device Technology Co., Ltd.

3. Block Diagram

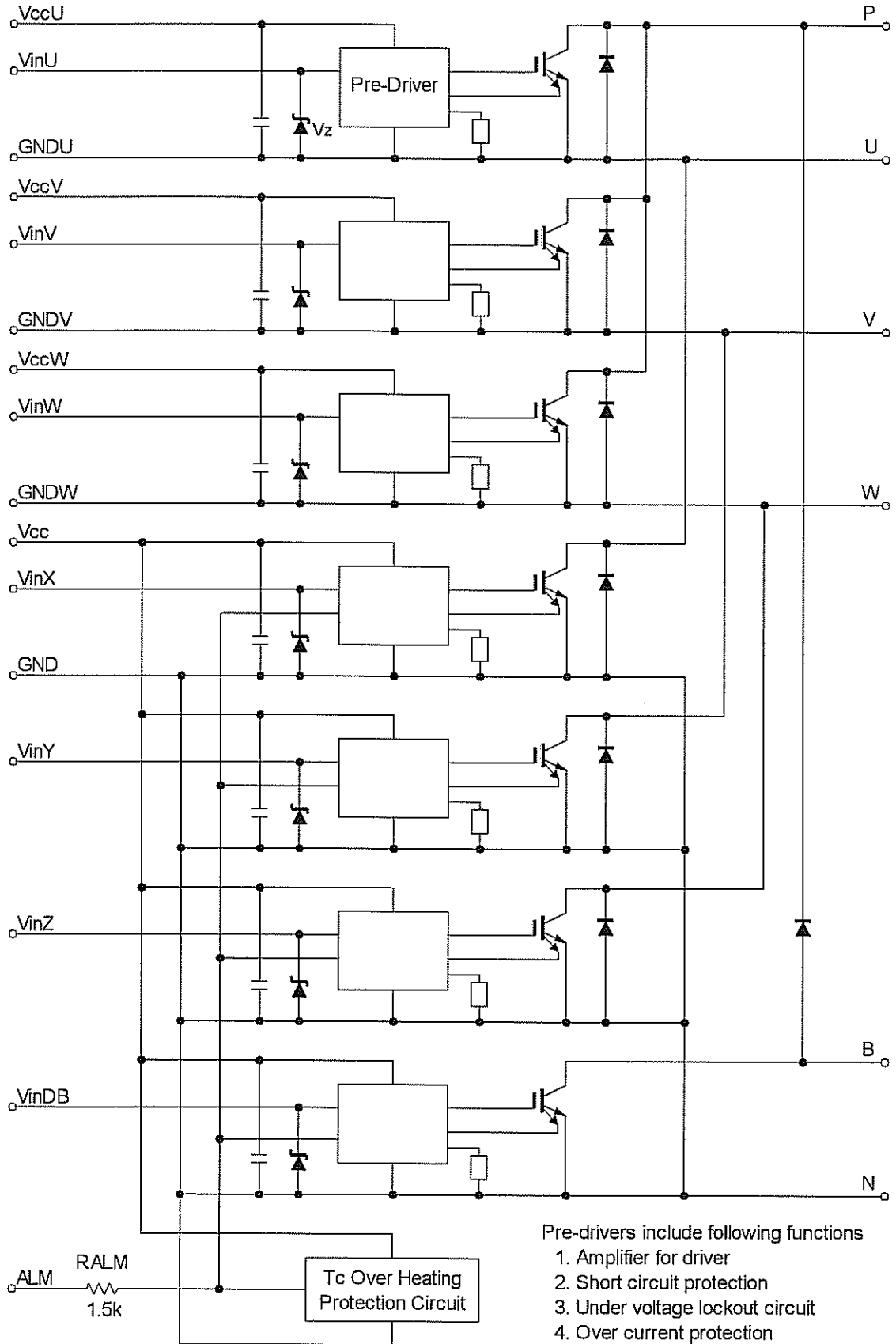

- Pre-drivers include following functions
1. Amplifier for driver
 2. Short circuit protection
 3. Under voltage lockout circuit
 4. Over current protection
 5. IGBT chip over heating protection

This material and the information herein is the property of Fuji Electric Device Technology Co., Ltd. They shall be neither reproduced, copied, lent, or disclosed in any way whatsoever for the use of any third party nor used for the manufacturing purposes without the express written consent of Fuji Electric Device Technology Co., Ltd.

4. Absolute Maximum Ratings

Tc=25°C unless otherwise specified.

Items		Symbol	Min.	Max.	Units	
Bus Voltage (between terminal P and N)	DC	V _{DC}	0	900	V	
	Surge	V _{DC(surge)}	0	1000	V	
	Short operating	V _{sc}	400	800	V	
Collector-Emitter Voltage	*1	V _{ces}	0	1200	V	
Inverter	Collector Current	DC	I _c	-	50	A
		1ms	I _{cp}	-	100	A
		Duty=100% *2	-I _c	-	50	A
Collector Power Dissipation	One transistor *3	P _c	-	300	W	
Brake	Collector Current	DC	I _c	-	25	A
		1ms	I _{cp}	-	50	A
	Forward Current of Diode	I _F	-	25	A	
	Collector Power Dissipation	One transistor *3	P _c	-	172	W
Supply Voltage of Pre-Driver	*4	V _{cc}	-0.5	20	V	
Input Signal Voltage	*5	V _{in}	-0.5	V _{cc} +0.5	V	
Input Signal Current		I _{in}	-	3	mA	
Alarm Signal Voltage	*6	VALM	-0.5	V _{cc}	V	
Alarm Signal Current	*7	I _{ALM}	-	20	mA	
Junction Temperature		T _J	-	150	°C	
Operating Case Temperature		T _{opr}	-20	100	°C	
Storage Temperature		T _{stg}	-40	125	°C	
Isolating Voltage	*8	V _{iso}	-	AC2500	V _{rms}	
Screw Torque	Terminal (M5)	-	-	3.5	Nm	
	Mounting (M5)					

Notes

- *1: V_{ces} shall be applied to the input voltage between terminal P and U or V or W or DB, N and U or V or W or DB
- *2: Duty=125°C/R_{th(j-c)}D/(I_c×V_F MAX) × 100
- *3: P_c=125°C/R_{th(j-c)}Q=300W (Inverter)
P_c=125°C/R_{th(j-c)}Q=172W (Brake)
- *4: V_{cc} shall be applied to the input voltage between terminal No.3 and 1, 6 and 4, 9 and 7, 11 and 10.
- *5: V_{in} shall be applied to the input voltage between terminal No.2 and 1, 5 and 4, 8 and 7, 12~15 and 10.
- *6: VALM shall be applied to the voltage between terminal No.16 and 10.
- *7: I_{ALM} shall be applied to the input current to terminal No.16.
- *8: Terminal to base, 50/60Hz sine wave 1min.

5. Electrical Characteristics

$T_j=25^{\circ}\text{C}$, $V_{cc}=15\text{V}$ unless otherwise specified.

5.1 Main circuit

Item		Symbol	Conditions		Min.	Typ.	Max.	Units
Inverter	Collector Current at off signal input	I_{CES}	$V_{ce}=1200\text{V}$ V_{in} terminal open.		-	-	1.0	mA
	Collector-Emitter saturation voltage	$V_{CE(sat)}$	$I_c=50\text{A}$ Fig.4	Terminal	-	1.9	2.2	V
				Chip	-	1.8	-	V
	Forward voltage of FWD	VF	$-I_c=50\text{A}$ Fig.5	Terminal	-	2.2	2.5	V
Chip				-	2.1	-	V	
Brake	Collector Current at off signal input	I_{CES}	$V_{ce}=1200\text{V}$ V_{in} terminal open.		-	-	1.0	mA
	Collector-Emitter saturation voltage	$V_{CE(sat)}$	$I_c=25\text{A}$ Fig.4	Terminal	-	1.9	2.2	V
				Chip	-	-	-	V
	Forward voltage of FWD	VF	$-I_c=25\text{A}$ Fig.5	Terminal	-	2.1	2.4	V
Chip				-	-	-	V	
Turn-on time		t_{on}	$V_{DC}=600\text{V}$, $T_j=125^{\circ}\text{C}$		1.2	1.8	-	μs
Turn-off time		t_{off}	$I_c=50\text{A}$ Fig.1,6		-	2.6	3.6	μs
Reverse recovery time		t_{rr}	$V_{DC}=600\text{V}$ $I_F=50\text{A}$ Fig.1,6		-	-	0.3	μs

5.2 Control circuit

Item		Symbol	Conditions		Min.	Typ.	Max.	Units
Supply current of P-side pre-driver (per one unit)		I_{ccp}	Switching Frequency = 0-15kHz		-	-	18	mA
Supply current of N-side pre-driver		I_{ccn}	$T_c=-20\sim 100^{\circ}\text{C}$ Fig.7		-	-	72	mA
Input signal threshold voltage	$V_{in(th)(on)}$	V_{in-GND}		ON	1.00	1.35	1.70	V
	$V_{in(th)(off)}$			OFF	1.25	1.60	1.95	V
Input Zener Voltage		V_z	$R_{in}=20\text{k}\Omega$		-	8.0	-	V
Alarm Signal Hold Time	t_{ALM}	ALM-GND	Fig.2	$T_c=-20^{\circ}\text{C}$	1.1	-	-	ms
				$T_c=25^{\circ}\text{C}$	-	2.0	-	ms
				$T_c=125^{\circ}\text{C}$	-	-	4.0	ms
Resistor for current limit		RALM			1425	1500	1575	Ω

This material and the information herein is the property of Fuji Electric Device Technology Co., Ltd. They shall be neither reproduced, copied, lent, or disclosed in any way whatsoever for the use of any third party nor used for the manufacturing purposes without the express written consent of Fuji Electric Device Technology Co., Ltd.

This material and the information herein is the property of Fuji Electric Device Technology Co., Ltd. They shall be neither reproduced, copied, lent, or disclosed in any way whatsoever for the use of any third party nor used for the manufacturing purposes without the express written consent of Fuji Electric Device Technology Co., Ltd.

5.3 Protection Circuit (Vcc=15V)

Item		Symbol	Conditions	Min.	Typ.	Max.	Units
Over Current Protection Level	Inverter	Ioc	Tj=125°C Fig.3	75	-	-	A
	Brake			38	-	-	A
Over Current Protection Delay time		tdoc	Tj=125°C	-	5	-	µs
SC Protection Delay time		tsc	Tj=125°C Fig.8	-	-	8	µs
IGBT Chips Over Heating Protection Temperature Level		TjOH	Surface of IGBT Chips	150	-	-	°C
Over Heating Protection Hysteresis		TjH		-	20	-	°C
Case Over Heating Protection Temperature Level		TcOH	VDC=0V, Ic=0A Case Temperature	110	-	125	°C
Over Heating Protection Hysteresis		TcH		-	20	-	°C
Under Voltage Protection Level		VUV		11.0	-	12.5	V
Under Voltage Protection Hysteresis		VH		0.2	0.5	-	V

6. Thermal Characteristics (Tc = 25°C)

Item		Symbol	Min.	Typ.	Max.	Units	
Junction to Case Thermal Resistance *9	Inverter	IGBT	Rth(j-c)Q	-	-	0.42	°C/W
		FWD	Rth(j-c)D	-	-	0.99	°C/W
	Brake	IGBT	Rth(j-c)Q	-	-	0.73	°C/W
		FWD	Rth(j-c)D	-	-	2.05	°C/W
Case to Fin Thermal Resistance with Compound		Rth(c-f)	-	0.05	-	°C/W	

*9: For 1device , Case is under the device

7. Noise Immunity (Vdc=300V, Vcc=15V, Test Circuit Fig 9.)

Item	Conditions	Min.	Typ.	Max.	Units
Common mode rectangular noise	Pulse width 1us,polarity ±, 10 minuets	±2.0	-	-	kV
	Judge: no over-current, no miss operating				
Common mode lightning surge	Rise time 1.2us,Fall time 50usInterval 20s, 10 times	±5.0	-	-	kV
	Judge: no over-current, no miss operating				

8. Recommended Operating Conditions

Item	Symbol	Min.	Typ.	Max.	Units
DC Bus Voltage	VDC	-	-	800	V
Power Supply Voltage of Pre-Driver	Vcc	13.5	15.0	16.5	V
Screw Torque (M5)	-	2.5	-	3.0	Nm

9. Weight

Item	Symbol	Min.	Typ.	Max.	Units
Weight	Wt	-	450	-	g

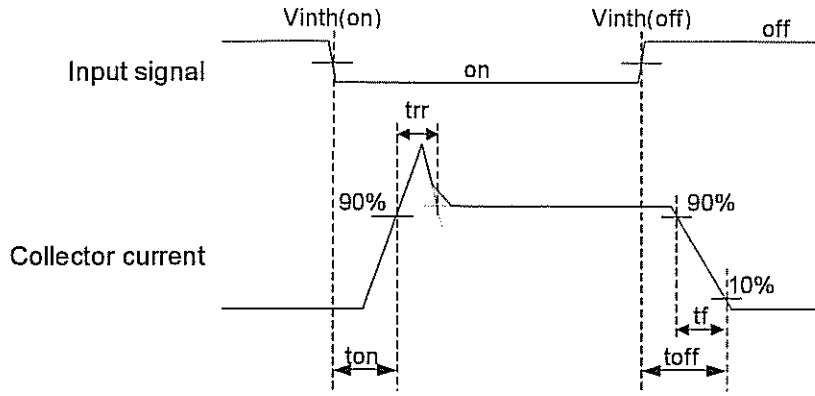

Figure1. Switching Time Waveform Difinitions.

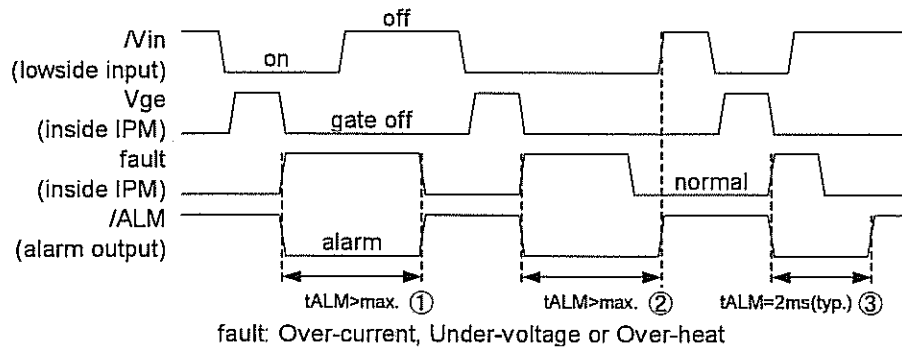

Figure2. Input/Output Timing Diagram.

Necessary conditions for alarm reset (refer to ① to ③ in figure2.)

- ① This represents the case when a failure-causing Fault lasts for a period more than t_{ALM} . The alarm resets when the input V_{in} is OFF and the Fault has disappeared.
- ② This represents the case when the ON condition of the input V_{in} lasts for a period more than t_{ALM} . The alarm resets when the V_{in} turns OFF under no Fault conditions.
- ③ This represents the case when the Fault disappears and the V_{in} turns OFF within t_{ALM} . The alarm resets after lasting for a period of the specified time t_{ALM} .

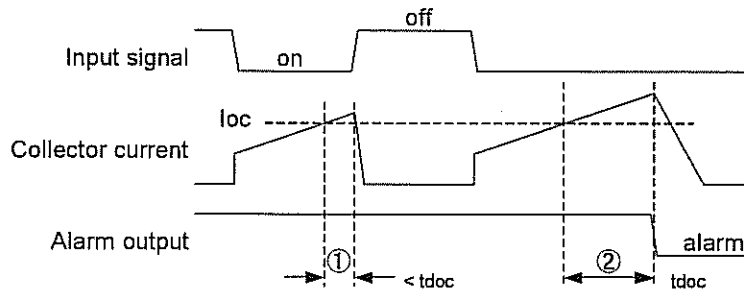

Figure3. Over-current Protection Timing Diagram.

- Period ①: When a collector current over the OC level flows and the OFF command is input within a period less than the trip delay time t_{doc} , the current is hard-interrupted and no alarm is output.
- Period ②: When a collector current over the OC level flows for a period more than the trip delay time t_{doc} , the current is soft-interrupted. If this is detected at the lower arm IGBTs, an alarm is output.

This material and the information herein is the property of Fuji Electric Device Technology Co., Ltd. They shall be neither reproduced, copied, lent, or disclosed in any way whatsoever for the use of any third party nor used for the manufacturing purposes without the express written consent of Fuji Electric Device Technology Co., Ltd.

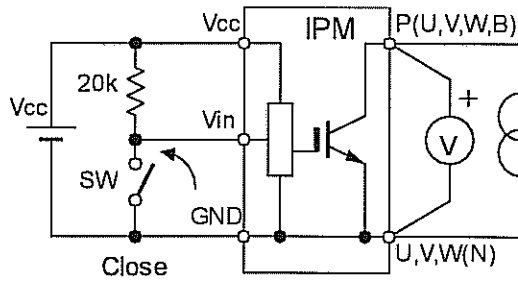

Figure4. Vce(sat) Test Circuit (Terminal)

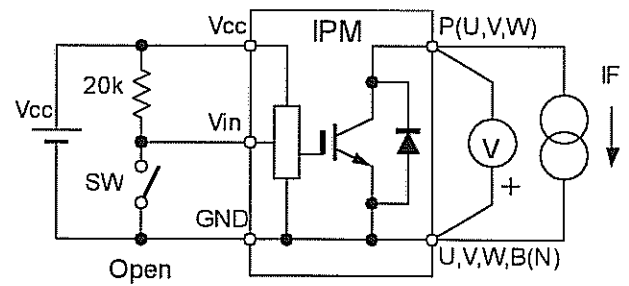

Figure5. VF Test Circuit (Terminal)

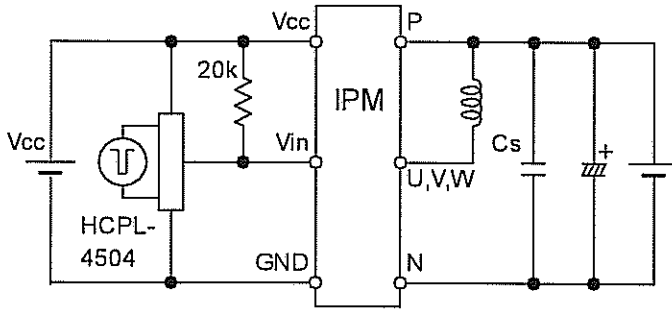

Figure6. Switching Characteristics Test Circuit

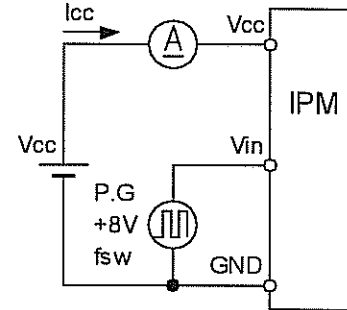

Figure7. Icc Test Circuit

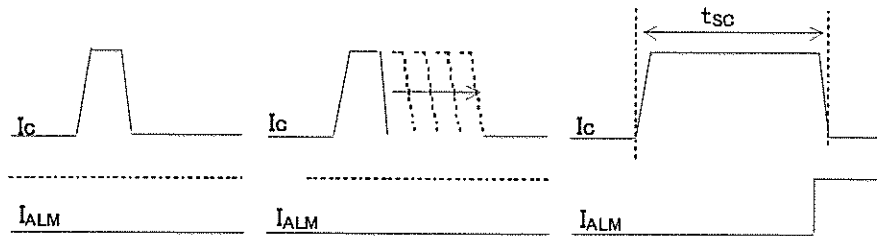

Figure8. Definition of tsc

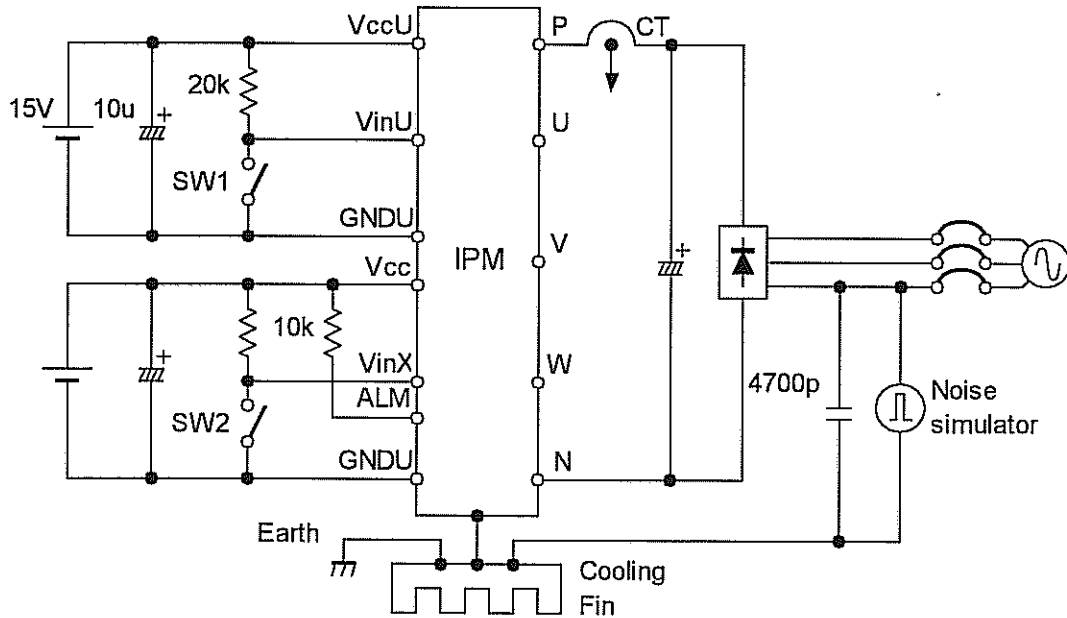

Figure9. Noise Test Circuit

10. Truth table

10.1 IGBT Control

The following table shows the IGBT ON/OFF status with respect to the input signal
The IGBT turn-on when Vin is at "Low" level under no alarm condition.

Input signal	Alarm output	Output (IGBT)
Low	High	On
Low	Low	Off
High	-	Off

10.2 Fault Detection

- (1) When a fault is detected at the high side, only the detected arm stops its output.
At that time the IPM doesn't any alarm.
- (2) When a fault is detected at the low side, all the lower arms stop their outputs
and the IPM outputs an alarm of the low side.

	Cause of fault	Operation of IGBT				Alarm Output
		High side			Low side	
		U-phase	V-phase	W-phase		
High side U-phase	OC	OFF	*	*	*	High
	UV	OFF	*	*	*	High
	TjOH	OFF	*	*	*	High
High side V-phase	OC	*	OFF	*	*	High
	UV	*	OFF	*	*	High
	TjOH	*	OFF	*	*	High
High side W-phase	OC	*	*	OFF	*	High
	UV	*	*	OFF	*	High
	TjOH	*	*	OFF	*	High
Low side	OC	*	*	*	OFF	Low
	UV	*	*	*	OFF	Low
	TjOH	*	*	*	OFF	Low
	TcOH	*	*	*	OFF	Low

*: Depend on input logic.

11. Cautions for design and application

- (1) Trace routing layout should be designed with particular attention to least stray capacity between the primary and secondary sides of optical isolators by minimizing the wiring length between the optical isolators and the IPM input terminals as possible.

フォトカブラとIPMの入力端子間の配線は極力短くし、

フォトカブラの一次側と二次側の浮遊容量を小さくしたパターンレイアウトにして下さい。

- (2) Mount a capacitor between Vcc and GND of each high-speed optical isolator as close to as possible.

高速フォトカブラのVcc-GND間に、コンデンサを出来るだけ近接して取り付けて下さい。

- (3) For the high-speed optical isolator, use high-CMR type one with $tp_{HL}, tp_{LH} \leq 0.8\mu s$.

高速フォトカブラは、 $tp_{HL}, tp_{LH} \leq 0.8\mu s$ 、高CMRタイプをご使用ください。

- (4) For the alarm output circuit, use low-speed type optical isolators with $CTR \geq 100\%$.

アラーム出力回路は、低速フォトカブラ $CTR \geq 100\%$ のタイプをご使用ください。

- (5) For the control power Vcc, use four power supplies isolated each. And they should be designed to reduce the voltage variations.

制御電源Vccは、絶縁された4電源を使用してください。また、電圧変動を抑えた設計として下さい。

- (6) Suppress surge voltages as possible by reducing the inductance between the DC bus P and N, and connecting some capacitors between the P and N terminals.

P-N間の直流母線は出来るだけ低インダクタンス化し、

P-N端子間にコンデンサを接続するなどしてサージ電圧を低減して下さい。

- (7) To prevent noise intrusion from the AC lines, connect a capacitor of some 4700pF between the three-phase lines each and the ground.

ACラインからのノイズ侵入を防ぐために、3相各線-アース間に4700pF程のコンデンサを接続して下さい。

- (8) At the external circuit, never connect the control terminal GNDU to the main terminal U-phase, GNDV to V-phase, GNDW to W-phase, and GND to N-phase. Otherwise, malfunctions may be caused.

制御端子GNDUと主端子U相、制御端子GNDVと主端子V相、制御端子GNDWと主端子W相、制御端子GNDと主端子Nを外部回路で接続しないで下さい。誤動作の原因になります。

- (9) Take note that an optical isolator's response to the primary input signal becomes slow if a capacitor is connected between the input terminal and GND.

入力端子-GND間にコンデンサを接続すると、フォトカブラ一次側入力信号に対する応答時間が長くなりますのでご注意ください。

- (10) Taking the used isolator's CTR into account, design with a sufficient allowance to decide the primary forward current of the optical isolator.
 フォトカブラの一次側電流は、お使いのフォトカブラのCTRを考慮し十分に余裕をもった設計して下さい。
- (11) In case of mounting this product on cooling fin, use thermal compound to secure thermal conductivity. If the thermal compound amount was not enough or its applying method was not suitable, its spreading will not be enough, then, thermal conductivity will be worse and thermal run away destruction may occur.
 Confirm spreading state of the thermal compound when its applying to this product.
 (Spreading state of the thermal compound can be confirmed by removing this product after mounting.)
 素子を冷却フィンに取り付ける際には、熱伝導を確保するためのコンパウンド等をご使用ください。
 又、塗布量が不足したり、塗布方法が不適だったりすると、コンパウンドが十分に素子全体に広がらず、放熱悪化による熱暴走破壊に繋がる事があります。コンパウンドを塗布する際には、製品全面にコンパウンドが広がっている事を確認してください。
 (実装した後に素子を取りはずすとコンパウンドの広がり具合を確認する事が出来ます。)
- (12) Use this product with keeping the cooling fin's flatness between screw holes within 100um at 100mm and the roughness within 10um. Also keep the tightening torque within the limits of this specification. Too large convex of cooling fin may cause isolation breakdown and this may lead to a critical accident. On the other hand, too large concave of cooling fin makes gap between this product and the fin bigger, then, thermal conductivity will be worse and over heat destruction may occur.
 冷却フィンはネジ取り付け位置間で平坦度を100mmで100um以下、表面の粗さは10um以下にして下さい。
 過大な凸反りがあったりすると本製品が絶縁破壊を起こし、重大事故に発展する場合があります。
 また、過大な凹反りやゆがみ等があると、本製品と冷却フィンの上に空隙が生じて放熱が悪くなり、熱破壊に繋がる事があります。
- (13) This product is designed on the assumption that it applies to an inverter use. Sufficient examination is required when applying to a converter use. Please contact Fuji Electric Co.,Ltd if you would like to applying to converter use.
 本製品は、インバータ用途への適用を前提に設計されております。コンバータ用途へ適用される場合は、十分な検討が必要です。もし、コンバータへ適用される場合は御連絡ください。
- (14) Please see the 『IGBT-IPM APPLICATION MANUAL』 and 『IGBT MODULES APPLICATION MANUAL』
 『IGBT-IPM アプリケーションマニュアル』及び『IGBTモジュール アプリケーションマニュアル』
 を御参照ください。

12. Example of applied circuit

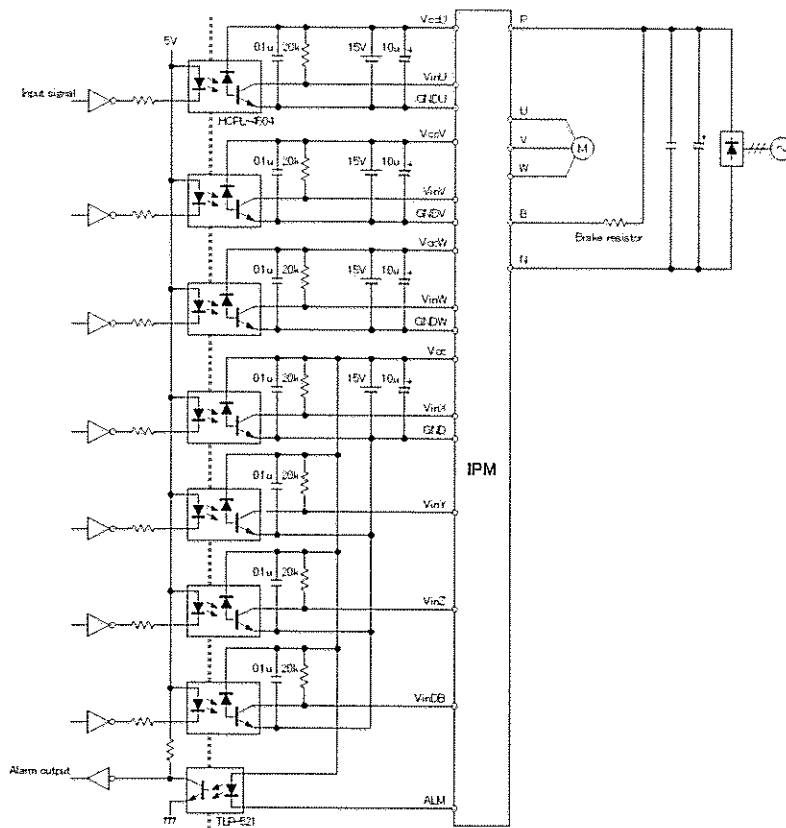

13. Package and Marking

Please see the packing specification of IPM (Technical Rep. No. : MT6M04140).

IPM 梱包仕様書MT6M04140を御参照ください。

14. Cautions for storage and transportation

- Store the modules at the normal temperature and humidity (5 to 35°C, 45 to 75%).
常温常湿(5~35°C、45~75%)で保存して下さい。
- Avoid a sudden change in ambient temperature to prevent condensation on the module surfaces.
モジュールの表面が結露しないよう、急激な温度変化を避けて下さい。
- Avoid places where corrosive gas generates or much dust exists.
腐食性ガスの発生場所、粉塵の多い場所は避けて下さい。
- Store the module terminals under unprocessed conditions
モジュールの端子は未加工の状態での保管すること。
- Avoid physical shock or falls during the transportation.
運搬時に衝撃を与えたり落下させないで下さい。

15. Scope of application

This specification is applied to the IGBT-IPM (type: 7MBP50RU2A120).

本仕様書は、IGBT-IPM (型式: 7MBP50RU2A120)に適用する。

16. Based safety standards

UL1557

17. Characteristics

17.1 Control Circuit Characteristics (Representative)

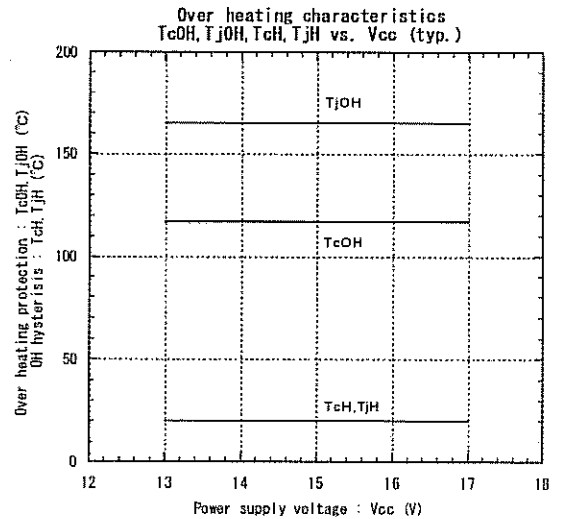
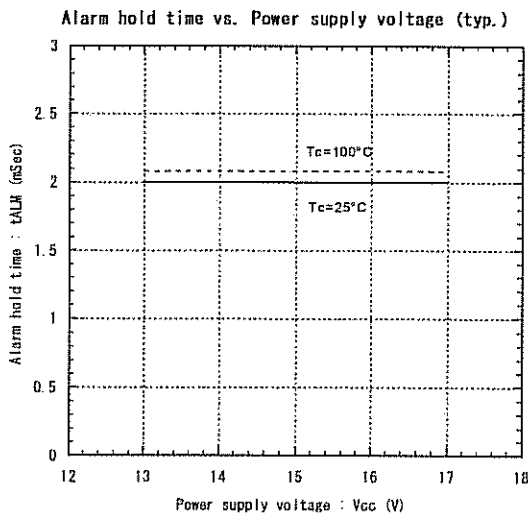
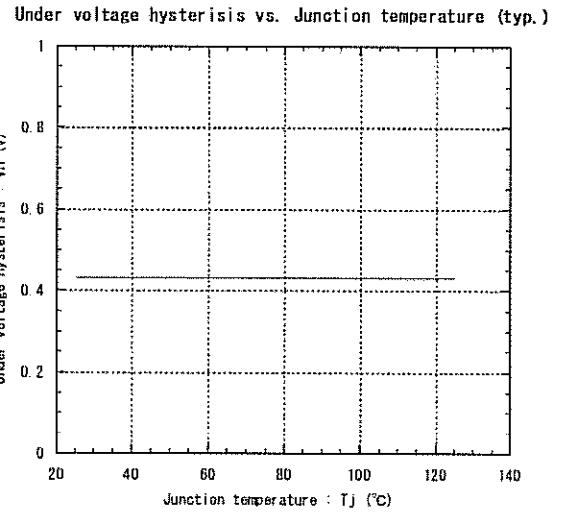
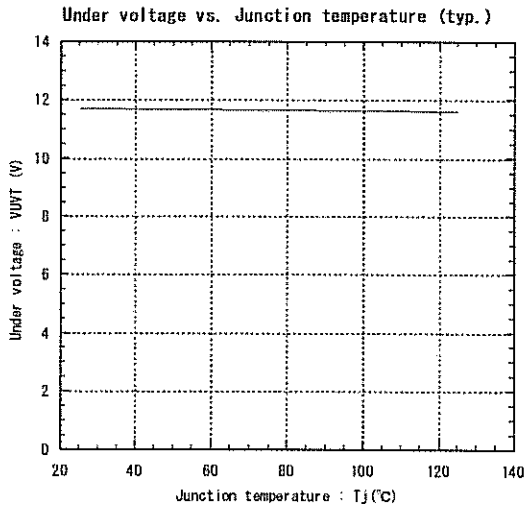
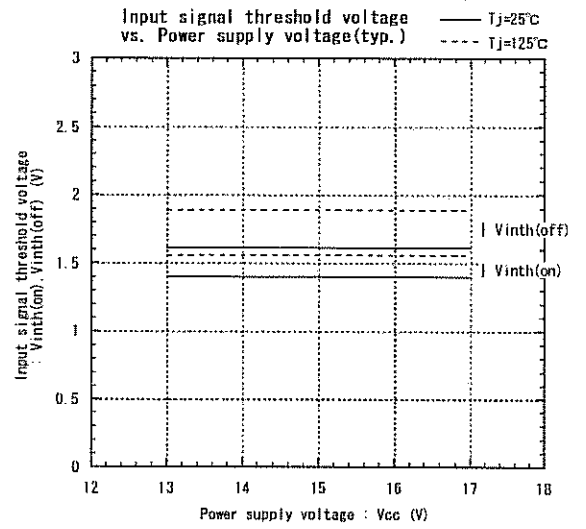
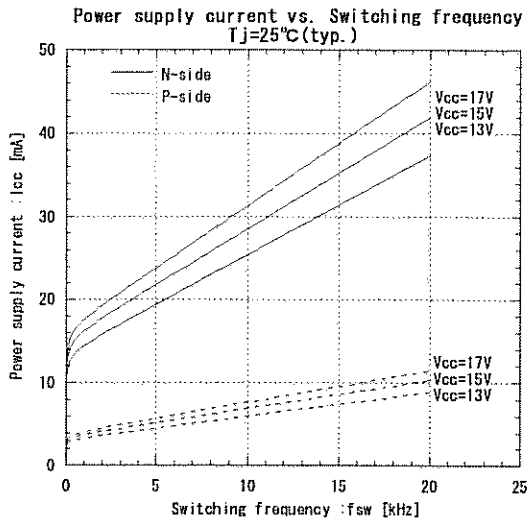

This material and the information herein is the property of Fuji Electric Device Technology Co., Ltd. They shall be neither reproduced, copied, lent, or disclosed in any way whatsoever for the use of any third party nor used for the manufacturing purposes without the express written consent of Fuji Electric Device Technology Co., Ltd.

17.2 Main Circuit Characteristics (Representative)

Collector current vs. Collector-Emittor voltage (typ.)
T_j=25°C (Chip)

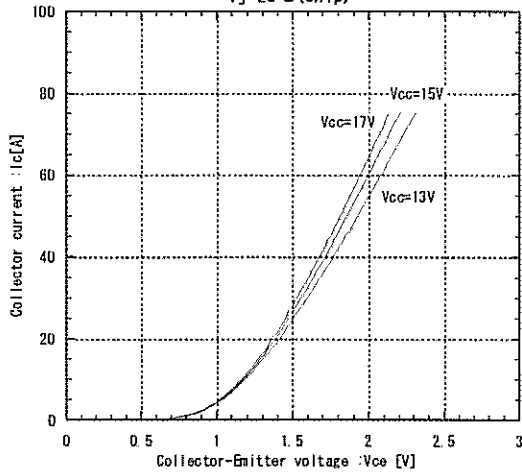

Collector current vs. Collector-Emittor voltage (typ.)
T_j=25°C (Terminal)

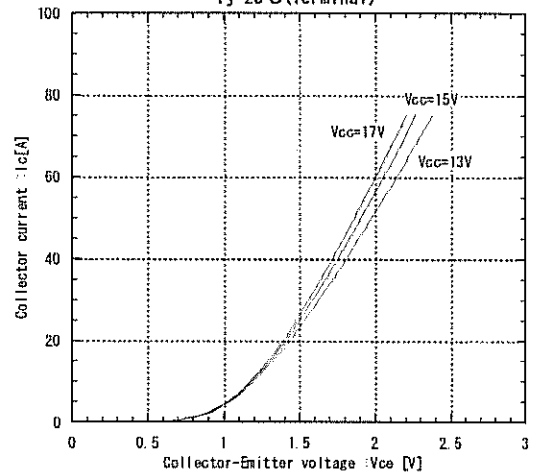

Collector current vs. Collector-Emittor voltage (typ.)
T_j=125°C (Chip)

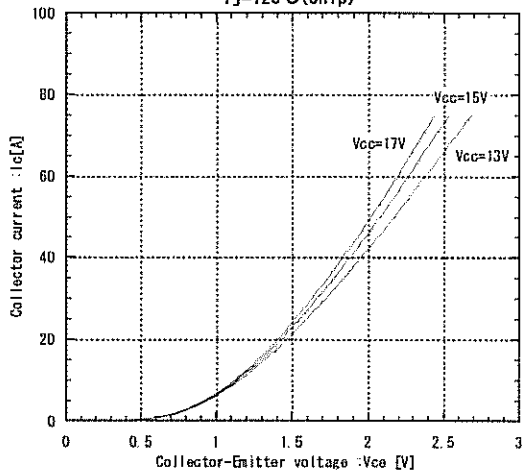

Collector current vs. Collector-Emittor voltage (typ.)
T_j=125°C (Terminal)

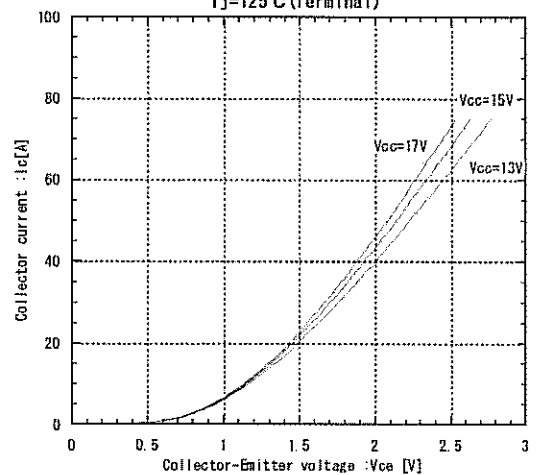

Forward current vs. Forward voltage (typ.)
(Chip)

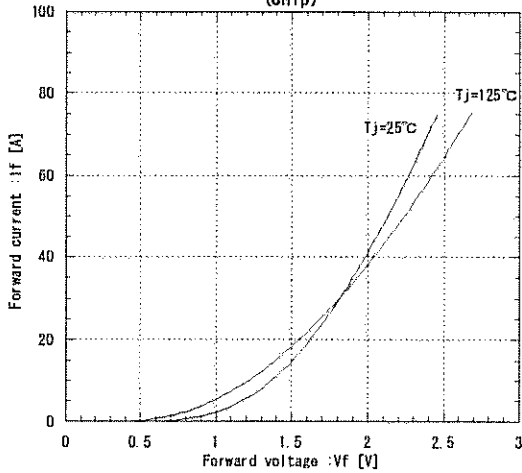

Forward current vs. Forward voltage (typ.)
(Terminal)

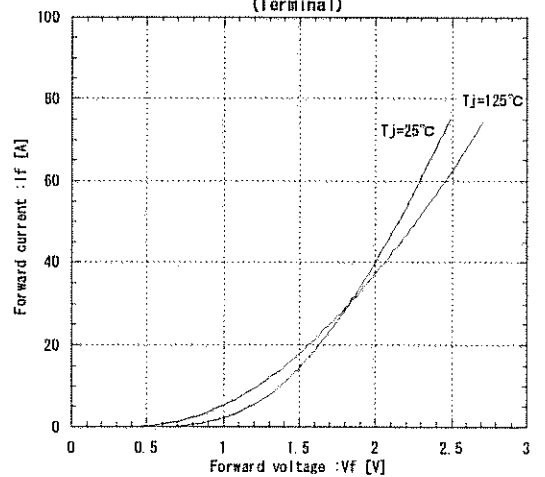

This material and the information herein is the property of Fuji Electric Device Technology Co., Ltd. They shall be neither reproduced, copied, lent, or disclosed in any way whatsoever for the use of any third party nor used for the manufacturing purposes without the express written consent of Fuji Electric Device Technology Co., Ltd.

This material and the information herein is the property of Fuji Electric Device Technology Co., Ltd. They shall be neither reproduced, copied, lent, or disclosed in any way whatsoever for the use of any third party nor used for the manufacturing purposes without the express written consent of Fuji Electric Device Technology Co., Ltd.

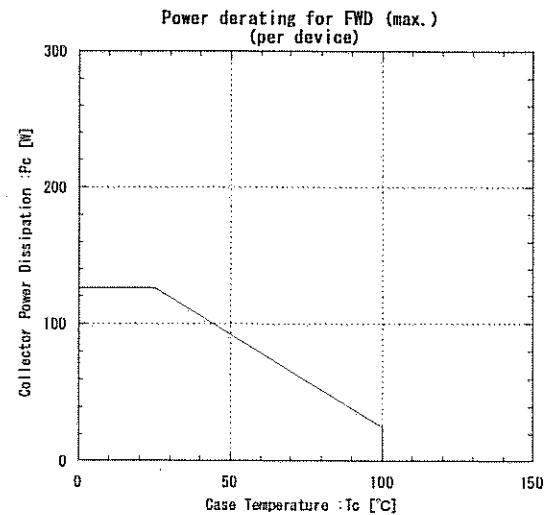
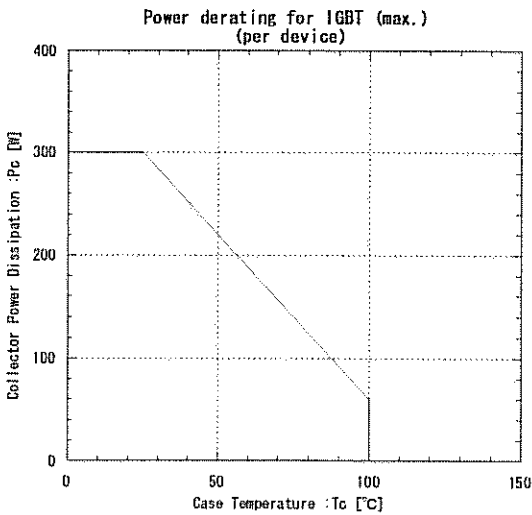
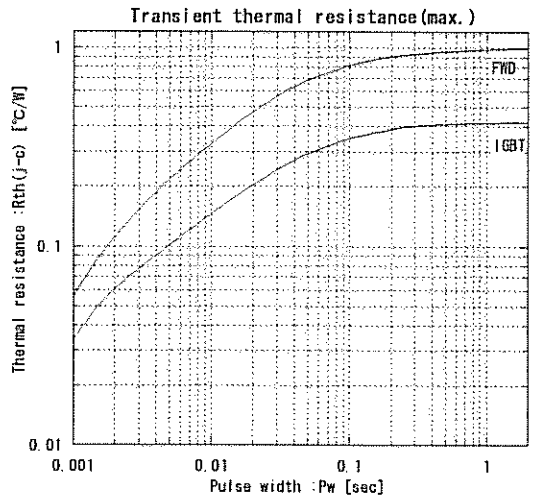
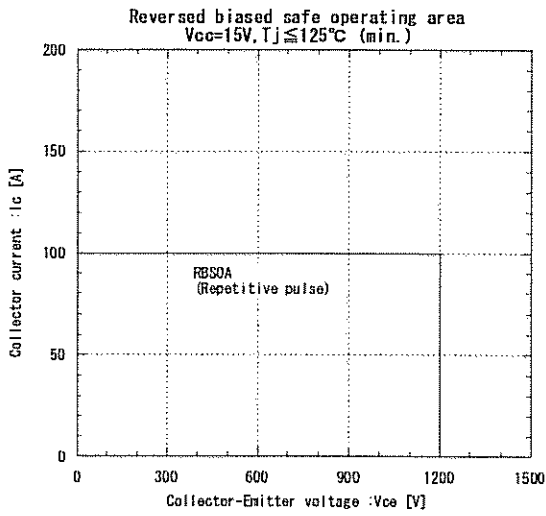
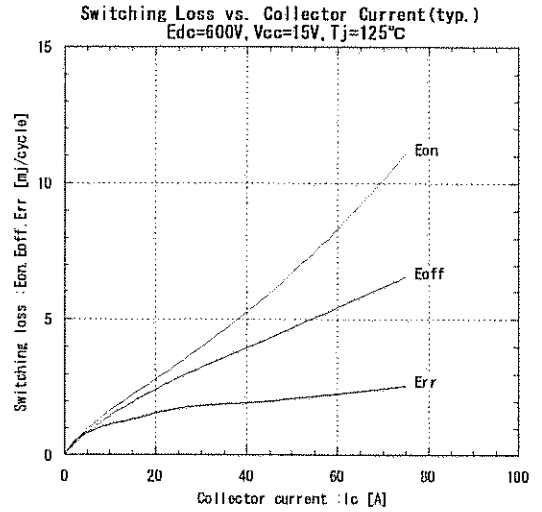
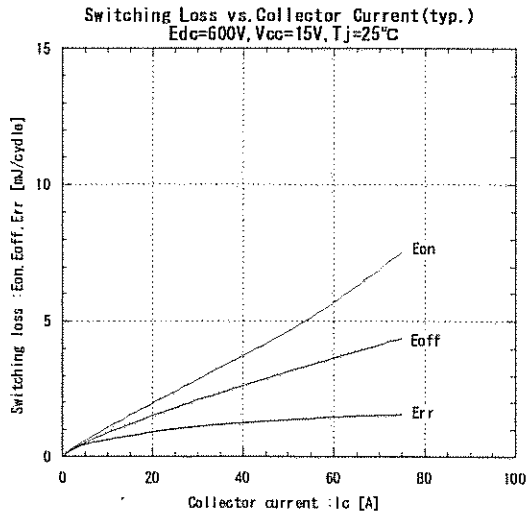

This material and the information herein is the property of Fuji Electric Device Technology Co., Ltd. They shall be neither reproduced, copied, lent, or disclosed in any way whatsoever for the use of any third party nor used for the manufacturing purposes without the express written consent of Fuji Electric Device Technology Co., Ltd.

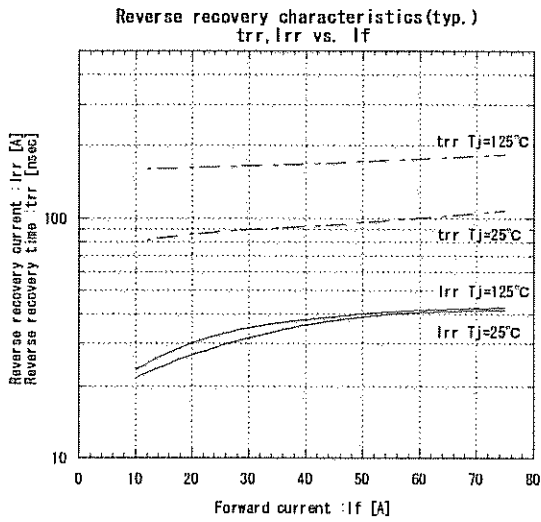
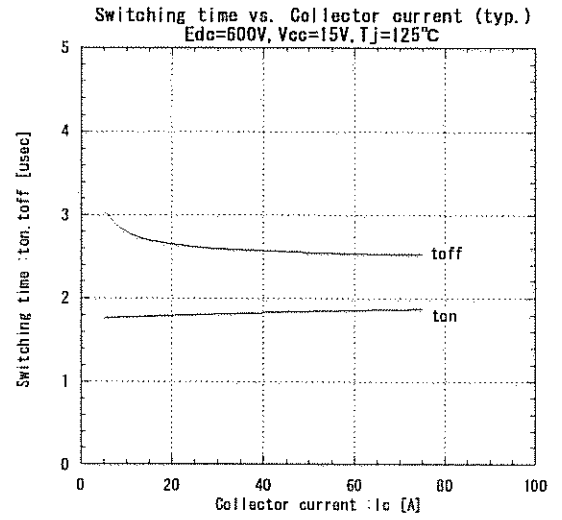
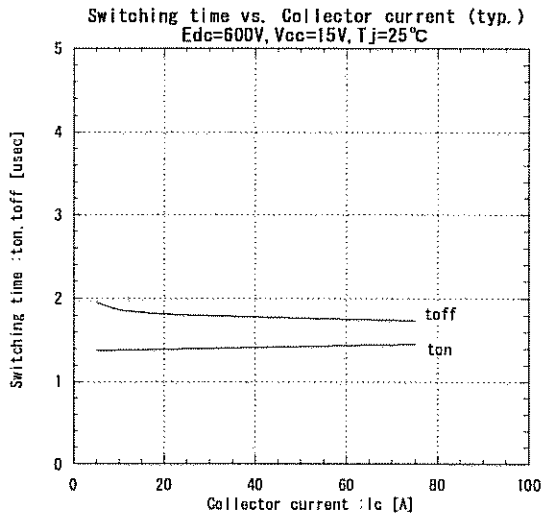

17.2 Dynamic Brake Characteristics (Representative)

Collector current vs. Collector-Emittor voltage (typ.)
T_J=25°C (Terminal)

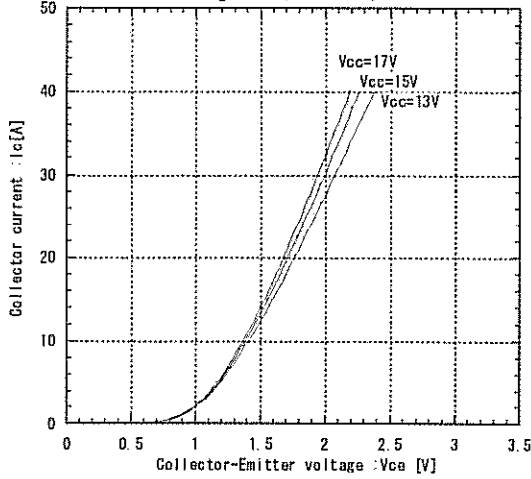

Collector current vs. Collector-Emittor voltage (typ.)
T_J=125°C (Terminal)

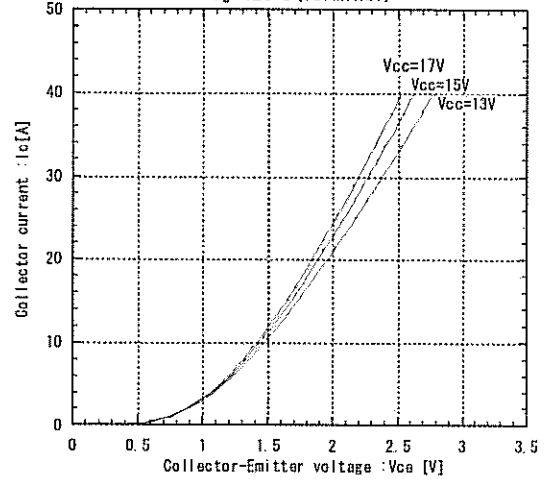

Forward current vs. Forward voltage (typ.)
(Terminal)

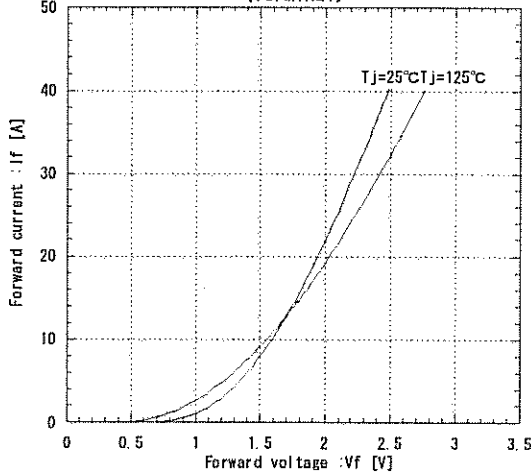

Transient thermal resistance (max.)

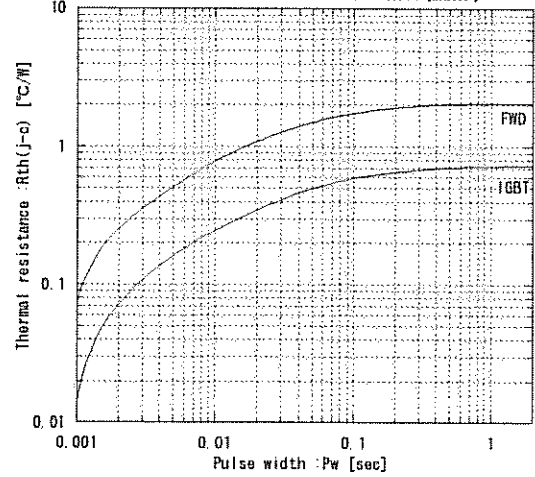

Reversed biased safe operating area
V_{ce}=15V, T_J ≤ 125°C (min.)

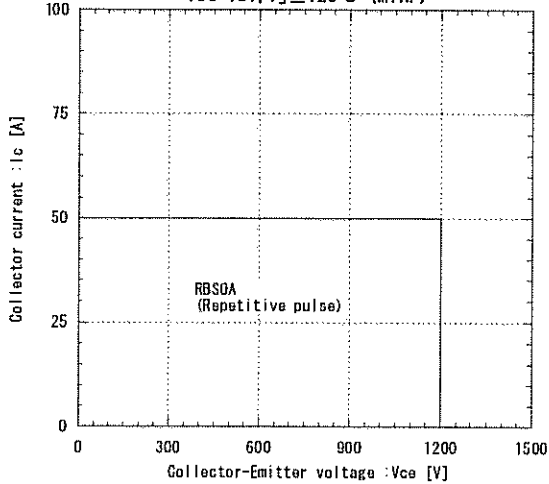

Power derating for IGBT (max.)
(per device)

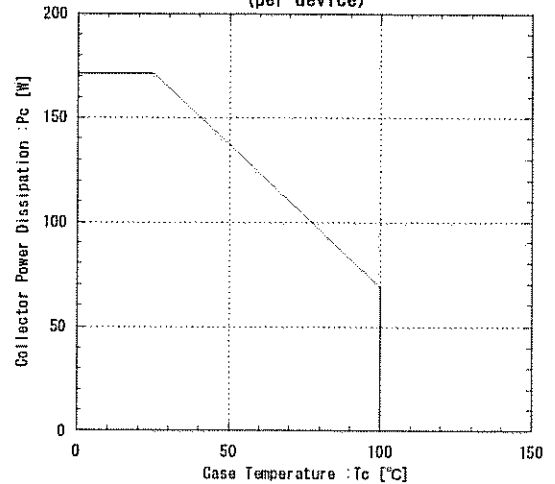

This material and the information herein is the property of Fuji Electric Device Technology Co., Ltd. They shall be neither reproduced, copied, lent, or disclosed in any way whatsoever for the use of any third party nor used for the manufacturing purposes without the express written consent of Fuji Electric Device Technology Co., Ltd.

18. Reliability Test

Test condions and results

Test categories	No.	Test items	Test methods and conditions	Reference norms EIAJ ED-4701	Number of sample	Acceptance number	Number of failure
Mechanical Tests	1	Terminal strength (Pull test)	Pull force : 40 N (main terminal) 10 N (control terminal) Test time : 10 ±1 sec.	Test Method 401 Method I	5	(1 : 0)	0
	2	Mounting Strength	Screw torque : 2.5 ~ 3.5 N·m (M5) Test time : 10 ±1 sec.	Test Method 402 method II	5	(1 : 0)	0
	3	Vibration	Range of frequency : 10~500 Hz Sweeping time : 15 min. Acceleration : 100 m/s ² Sweeping direction : Each X,Y,Z axis Test time : 6 hr. (2hr./direction)	Test Method 403 Condition code B	5	(1 : 0)	0
	4	Shock	Maximum acceleratic : 5000 m/s ² Pulse width : 1.0 ms Direction : Each X,Y,Z axis Test time : 3 times/direction	Test Method 404 Condition code B	5	(1 : 0)	0
	5	Solderability	Solder temp. : 235 ±5 °C Immersion duration : 5.0 ±0.5 sec. Test time : 1 time Each terminal should be Immersed in solder within 1~1.5mm from the body.	Test Method 303 Condition code A	5	(1 : 0)	0
	6	Resistance to soldering heat	Solder temp. : 260 ±5 °C Immersion time : 10 ±1 sec. Test time : 1 time Each terminal should be Immersed in solder within 1~1.5mm from the body.	Test Method 302 Condition code A	5	(1 : 0)	0
Environment Tests	1	High temperature storage	Storage temp. : 125 ±5 °C Test duration : 1000 hr.	Test Method 201	5	(1 : 0)	0
	2	Low temperature storage	Storage temp. : -40 ±5 °C Test duration : 1000 hr.	Test Method 202	5	(1 : 0)	0
	3	Temperature humidity storage	Storage temp. : 85 ±2 °C Relative humidity : 85 ±5% Test duration : 1000hr.	Test Method 103 Test code C	5	(1 : 0)	0
	4	Unsaturated pressure cooker	Test temp. : 120 ±2 °C Atmospheric pressur : 1.7x10 ⁵ Pa Test humidity : 85 ±5% Test duration : 96 hr.	Test Method 103 Test code E	5	(1 : 0)	0
	5	Temperature cycle	Test temp. : Minimum storage temp. -40 ±5°C Maximum storage temp. 125 ±5°C Normal temp. 5 ~ 35°C Dwell time : Tmin ~ TN ~ Tmax ~ TN 1hr. 0.5hr. 1hr. 0.5hr. Number of cycles : 100 cycles	Test Method 105	5	(1 : 0)	0
	6	Thermal shock	Test temp. : High temp. side 100 ⁺⁰ °C Low temp. side 0 ⁻⁵ °C Fluid used : Pure water (running water) Dipping time : 5 min. par each temp. Transfer time : 10 sec. Number of cycles : 10 cycles	Test Method 307 method I Condition code A	5	(1 : 0)	0

This material and the information herein is the property of Fuji Electric Device Technology Co.,Ltd. They shall be neither reproduced, copied, lent, or disclosed in any way whatsoever for the use of any third party nor used for the manufacturing purposes without the express written consent of Fuji Electric Device Technology Co.,Ltd.

This material and the information herein is the property of Fuji Electric Device Technology Co., Ltd. They shall be neither reproduced, copied, lent, or disclosed in any way whatsoever for the use of any third party nor used for the manufacturing purposes without the express written consent of Fuji Electric Device Technology Co., Ltd.

Test categories	No.	Test items	Test methods and conditions	Reference norms EIAJ ED-4701	Number of sample	Acceptance number
Endurance Tests	1	High temperature reverse bias	Test temp. : $T_a = 125 \pm 5^\circ\text{C}$: $(T_j \leq 150^\circ\text{C})$ Bias Voltage : $V_C = 0.8 \times V_{CES}$ Bias Method : Applied DC voltage to C-E : $V_{CC} = 15\text{V}$ Test duration : 1000 hr.	Test Method 101	5	(1:0)
	2	Intermitted operating life (Power cycle)	ON time : 2 sec. OFF time : 18 sec. Test temp. : $\Delta T_j = 100 \pm 5^\circ\text{deg}$: $T_j \leq 150^\circ\text{C}, T_a = 25 \pm 5^\circ\text{C}$ Number of cycles : 15000 cycles	Test Method 106	5	(1:0)

Failure Criteria

Item	Characteristic		Symbol	Failure criteria		Unit
				Lower limit	Upper limit	
Electrical characteristic	Leakage current		ICES	-	USL×2.0	mA
	Saturation voltage		VCE(sat)	-	USL×1.2	V
	Forward voltage		VF	-	USL×1.2	V
	Thermal resistance	IGBT	Rth(j-c)Q	-	USL×1.2	°C/W
		FWD	Rth(j-c)D	-	USL×1.2	°C/W
	Over Current Protection		Ioc	LSL×0.8	USL×1.2	A
	Alarm signal hold time		tALM	LSL×0.8	USL×1.2	ms
	Over heating Protection		TcOH	LSL×0.8	USL×1.2	°C
Isolation voltage		Viso	Broken insulation		-	
Visual inspection	Visual inspection		-	The visual sample	-	
	Peeling Plating and the others					

LSL : Lower specified limit.
 USL : Upper specified limit.

Note :

Each parameter measurement read-outs shall be made after stabilizing the components at room ambient for 2 hours minimum, 24 hours maximum after removal from the tests. And in case of the wetting tests, for example, moisture resistance tests, each component shall be made wipe or dry completely before the measurement.

Warnings

1. This product shall be used within its absolute maximum rating (voltage, current, and temperature).
This product may be broken in case of using beyond the ratings.
製品の絶対最大定格(電圧、電流、温度等)の範囲内で御使用下さい。
絶対最大定格を超えて使用すると、素子が破壊する場合があります。
2. Connect adequate fuse or protector of circuit between three-phase line and this product to prevent the equipment from causing secondary destruction.
万一の不慮の事故で素子が破壊した場合を考慮し、商用電源と本製品の間に適切な容量のヒューズ又はブレーカーを必ず付けて2次破壊を防いでください。
3. When studying the device at a normal turn-off action, make sure that working paths of the turn-off voltage and current are within the RBSOA specification.
通常のターンオフ動作における素子責務の検討の際には、
ターンオフ電圧・電流の動作軌跡がRBSOA仕様内にあることを確認して下さい。
4. Use this product after realizing enough working on environment and considering of product's reliability life. This product may be broken before target life of the system in case of using beyond the product's reliability life.
製品の使用環境を十分に把握し、製品の信頼性寿命が満足できるか検討の上、本製品を適用して下さい。
製品の信頼性寿命を超えて使用した場合、装置の目標寿命より前に素子が破壊する場合があります。
5. If the product had been used in the environment with acid, organic matter, and corrosive gas (For example : hydrogen sulfide, sulfurous acid gas), the product's performance and appearance can not be ensured easily.
酸・有機物・腐食性ガス(硫化水素、亜硫酸ガス等)を含む環境下で使用された場合、
製品機能・外観などの保証は致しかねます。
6. Use this product within the power cycle curve (Technical Rep.No. : MT5F12959).
Power cycle capability is classified to delta-Tj mode which is stated as above and delta-Tc mode.
Delta-Tc mode is due to rise and down of case temperature (Tc), and depends on cooling design of equipment which use this product. In application which has such frequent rise and down of Tc, well consideration of product life time is necessary.
本製品は、パワーサイクル寿命カーブ以下で使用下さい(技術資料No.: MT5F12959)。
パワーサイクル耐量にはこの ΔT_j による場合の他に、 ΔT_c による場合があります。
これはケース温度(T_c)の上昇下降による熱ストレスであり、本製品をご使用する際の放熱設計に依存します。
ケース温度の上昇下降が頻繁に起こる場合は、製品寿命に十分留意してご使用下さい。
7. Never add mechanical stress to deform the main or control terminal.
The deformed terminal may cause poor contact problem.
主端子及び制御端子に応力を与えて変形させないで下さい。
端子の変形により、接触不良などを引き起こす場合があります。

This material and the information herein is the property of Fuji Electric Device Technology Co., Ltd. They shall be neither reproduced, copied, lent, or disclosed in any way whatsoever for the use of any third party nor used for the manufacturing purposes without the express written consent of Fuji Electric Device Technology Co., Ltd.

This material and the information herein is the property of Fuji Electric Device Technology Co., Ltd. They shall be neither reproduced, copied, lent, or disclosed in any way whatsoever for the use of any third party nor used for the manufacturing purposes without the express written consent of Fuji Electric Device Technology Co., Ltd.

8. According to the outline drawing, select proper length of screw for main terminal.

Longer screws may break the case.

本製品に使用する主端子用のネジの長さは、外形図に従い正しく選定下さい。

ネジが長いとケースが破損する場合があります。

9. If excessive static electricity is applied to the control terminals, the devices can be broken.

Implement some countermeasures against static electricity.

制御端子に過大な静電気が印加された場合、素子が破壊する場合があります。

取り扱い時は静電気対策を実施して下さい。

Caution

1. Fuji Electric Device Technology is constantly making every endeavor to improve the product quality and reliability. However, semiconductor products may rarely happen to fail or malfunction. To prevent accidents causing injury or death, damage to property like by fire, and other social damage resulted from a failure or malfunction of the Fuji Electric semiconductor products, take some measures to keep safety such as redundant design, spread-fire-preventive design, and malfunction-protective design.

富士電機デバイステクノロジーは絶えず製品の品質と信頼性の向上に努めています。しかし、半導体製品は故障が発生したり、誤動作する場合があります。富士電機製半導体製品の故障または誤動作が、結果として人身事故・火災等による財産に対する損害や社会的な損害を起こさないように冗長設計・延焼防止設計・誤動作防止設計など安全確保のための手段を講じて下さい。

2. The application examples described in this specification only explain typical ones that used the Fuji Electric Device Technology products. This specification never ensure to enforce the industrial property and other rights, nor license the enforcement rights.

本仕様書に記載してある応用例は、富士電機デバイステクノロジー製品を使用した代表的な応用例を説明するものであり、本仕様書によって工業所有権、その他権利の実施に対する保障または実施権の許諾を行うものではありません。

3. The product described in this specification is not designed nor made for being applied to the equipment or systems used under life-threatening situations. When you consider applying the product of this specification to particular used, such as vehicle-mounted units, shipboard equipment, aerospace equipment, medical devices, atomic control systems and submarine relaying equipment or systems, please apply after confirmation of this product to be satisfied about system construction and required reliability.

本仕様書に記載された製品は、人命にかかわるような状況下で使用される機器あるいはシステムに用いられることを目的として設計・製造されたものではありません。本仕様書の製品を車両機器、船舶、航空宇宙、医療機器、原子力制御、海底中継機器あるいはシステムなど、特殊用途へのご利用をご検討の際は、システム構成及び要求品質に満足することをご確認の上、ご利用下さい。

If there is any unclear matter in this specification, please contact Fuji Electric Device Technology Co., Ltd.

本仕様書にご不明の点がありましたら、富士電機デバイステクノロジーにお問合せ下さい。