

IGBT MODULE

600V / 50A / PIM

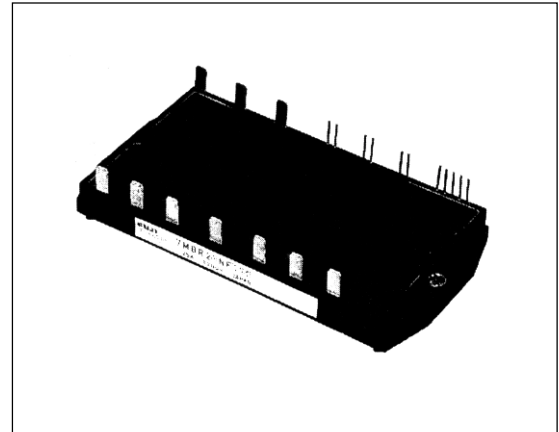

■ Features

- High Speed Switching
- Voltage Drive
- Low Inductance Module Structure
- Converter Diode Bridge Dynamic Brake Circuit

■ Applications

- Inverter for Motoe Drive
- AC and DC Servo Drive Amplifier
- Uninterruptible Power Supply

■ Maximum ratings and characteristics

● Absolute maximum ratings (Tc=25°C unless without specified)

Item	Symbol	Condition	Rating	Unit	
Inverter	Collector-Emitter voltage	V _{CES}	600	V	
	Gate-Emitter voltage	V _{GES}	±20	V	
	Collector current	DC	I _C	50	A
		1ms	I _{CP}	100	A
		DC	-I _C	50	A
Collector power dissipation	1 device	P _C	200	W	
Brake	Collector-Emitter voltage	V _{CES}	600	V	
	Gate-Emitter voltage	V _{GES}	±20	V	
	Collector current	DC	I _C	50	A
		1ms	I _{CP}	100	A
	Collector power dissipation	1 device	P _C	200	W
	Repetitive peak reverse voltage	V _{R_{RM}}		600	V
	Average forward current	I _{F(AV)}		1	A
	Surge current	I _{FSM}	10ms	50	A
	Converter	Repetitive peak reverse voltage	V _{R_{RM}}	800	V
		Non-Repetitive peak reverse voltage	V _{R_{SM}}	900	V
Average output current		I _O	50Hz/60Hz sine wave	50	A
Surge current (Non-Repetitive)		I _{FSM}	T _J =150°C, 10ms	350	A
I ² t (Non-Repetitive)			T _J =150°C, 10ms	648	A ² s
Operating junction temperature	T _J		+150	°C	
Storage temperature	T _{stg}		-40 to +125	°C	
Isolation voltage	V _{iso}	AC : 1 min.	AC 2500	V	
Mounting screw torque			1.7 *1	N·m	

*1 Recommendable value : 1.3 to 1.7 N·m (M4)

● Electrical characteristics (Tj=25°C unless without specified)

Item	Symbol	Condition	Characteristics			Unit	
			Min.	Typ.	Max.		
Inverter (IGBT)	Zero gate voltage collector current	ICES	VCE=600V, VGE=0V			1.0	mA
	Gate-Emitter leakage current	IGES	VCE=0V, VGE=±20V			20	µA
	Gate-Emitter threshold voltage	VGE(th)	VCE=20V, Ic=50mA			4.5	V
	Collector-Emitter saturation voltage	VCE(sat)	VGE=15V, Ic=50A			2.8	V
	Collector-Emitter voltage	-VCE	-Ic=50A			3.0	V
	Input capacitance	Cies	VGE=0V, VCE=10V, f=1MHz			3300	pF
	Switching time	ton	VCC=300V			1.2	µs
		tr	Ic=50A			0.6	µs
		toff	VGE=±15V			1.5	µs
		tf	RG=51 ohm			0.35	µs
Reverse recovery time of FRD	trr	IF=50A, VGE=-10V, -di/dt=150A/µs			300	ns	
Brake (IGBT)	Zero gate voltage collector current	ICES	VCE=600V, VGE=0V			1.0	mA
	Gate-Emitter leakage current	IGES	VCE=0V, VGE=±20V			100	nA
	Collector-Emitter saturation voltage	VCE(sat)	Ic=15A, VGE=15V			2.8	V
	Switching time	ton	VCC=300V			0.8	µs
		tr	Ic=50A			0.6	µs
		toff	VGE=±15V			1.0	µs
		tf	RG=51 ohm			0.35	µs
Brake (FWD)	Reverse current	IRRM	VR=600V			1.0	mA
	Reverse recovery time	trr				600	ns
Converter	Forward voltage	VFM	IF=50A			1.55	V
	Reverse current	IRRM	VR=800V			1.0	mA

● Thermal Characteristics

Item	Symbol	Condition	Characteristics			Unit
			Min.	Typ.	Max.	
Thermal resistance (1 device)	Rth(j-c)	Inverter IGBT			0.63	°C/W
		Inverter FRD			1.60	
		Brake IGBT			0.63	
		Converter Diode			2.10	
Contact thermal resistance *	Rth(c-f)	With thermal compound		0.05		

* This is the value which is defined mounting on the additional cooling fin with thermal compound

■ Equivalent Circuit Schematic

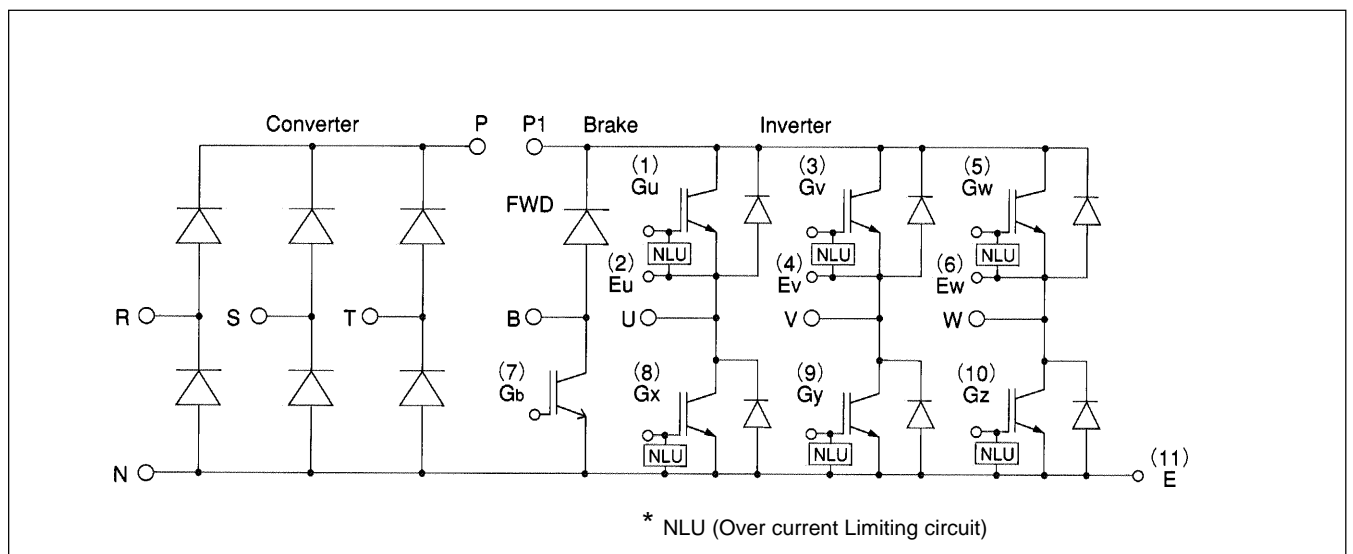

■ Characteristics (Representative)

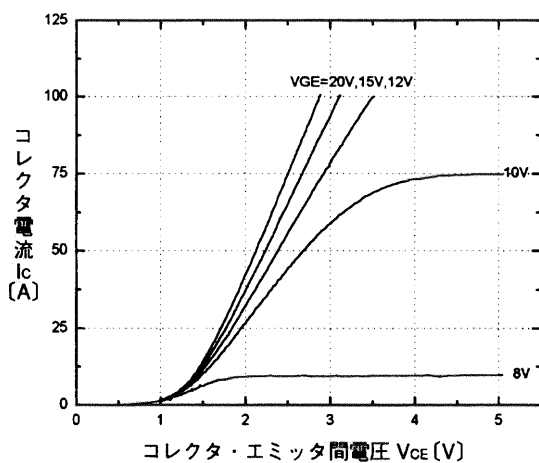

コレクタ電流-コレクタ・エミッタ間電圧特性 ($T_j=25^\circ\text{C}$) <INV部>
Collector current vs. Collector-Emitter voltage <INV>

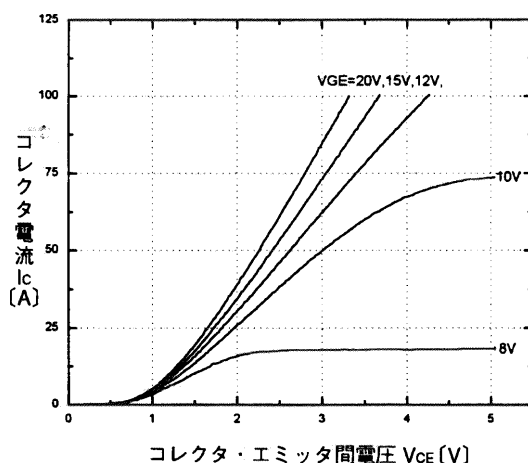

コレクタ電流-コレクタ・エミッタ間電圧特性 ($T_j=125^\circ\text{C}$) <INV部>
Collector current vs. Collector-Emitter voltage <INV>

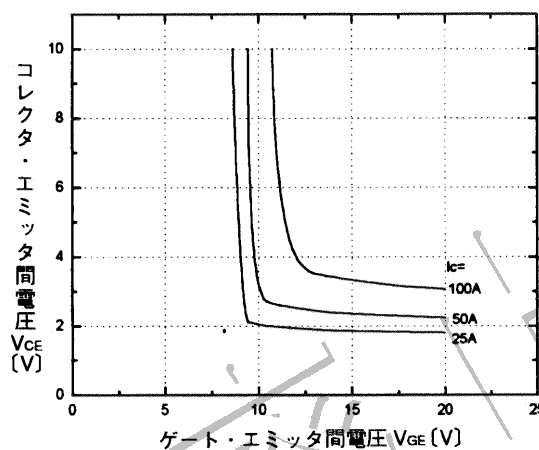

コレクタ・エミッタ間電圧-ゲート・エミッタ間電圧特性 ($T_j=25^\circ\text{C}$) <INV部>
Collector-Emitter voltage vs. Gate-Emitter voltage <INV>

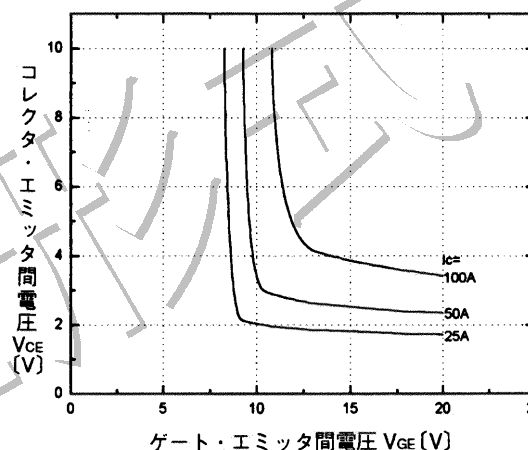

コレクタ・エミッタ間電圧-ゲート・エミッタ間電圧特性 ($T_j=125^\circ\text{C}$) <INV部>
Collector-Emitter voltage vs. Gate-Emitter voltage <INV>

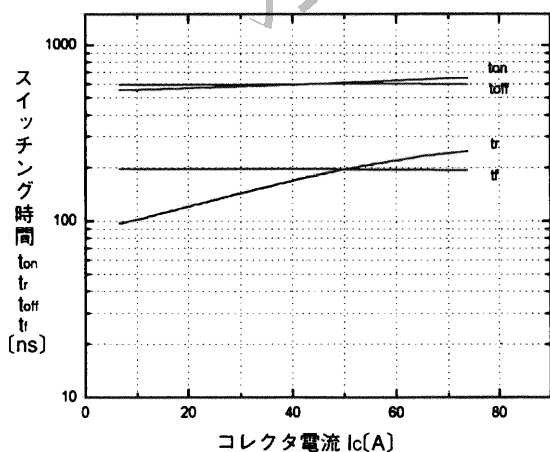

スイッチング時間-コレクタ電流特性 ($T_j=25^\circ\text{C}$) <INV部>
Switching time vs. Collector current <INV>

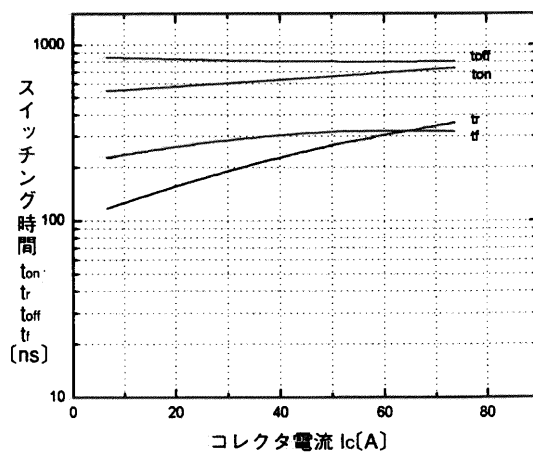

スイッチング時間-コレクタ電流特性 ($T_j=125^\circ\text{C}$) <INV部>
Switching time vs. Collector current <INV>

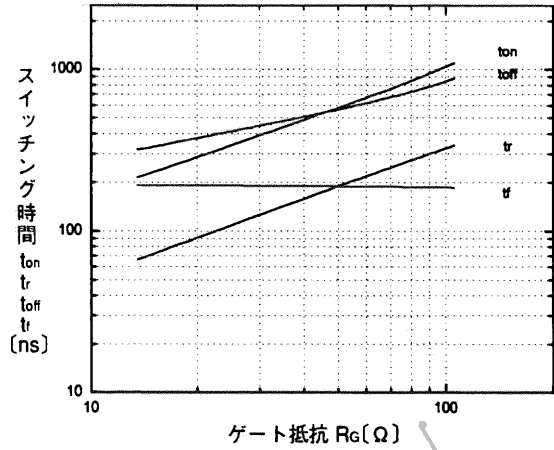

スイッチング時間-ゲート抵抗特性(T_J=25°C)<INV部>
Switching time vs. Gate resistance<INV>

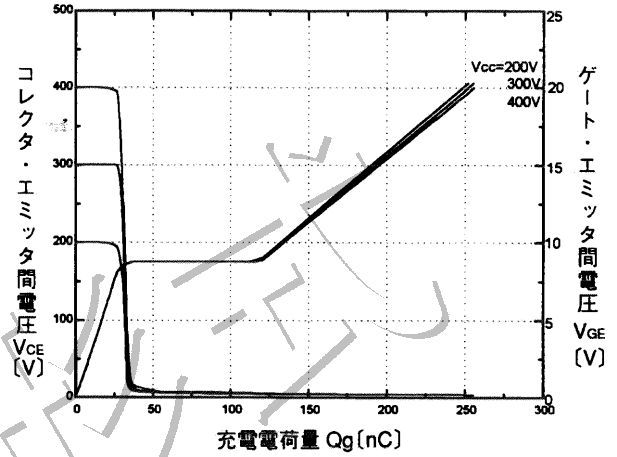

ダイナミック入力特性(T_J=25°C)<INV部>
Dynamic input characteristic<INV>

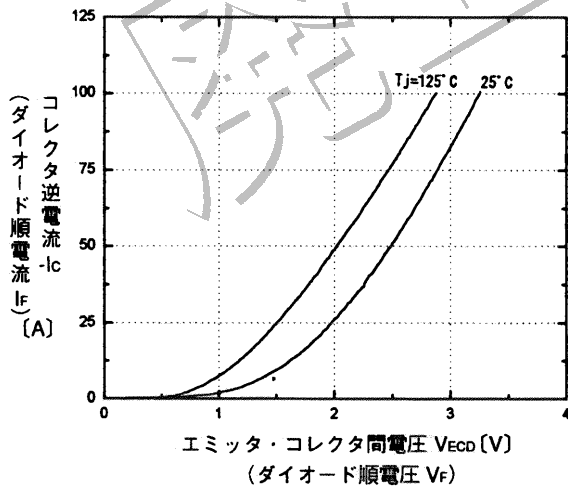

高速フリーホイールダイオード順電圧特性<INV部>
Forward voltage of free wheel diode<INV>

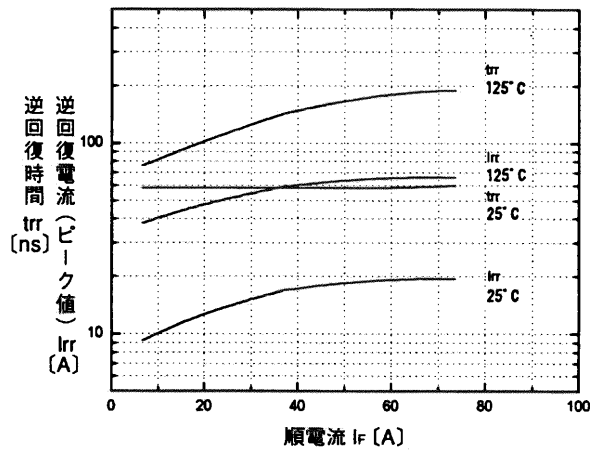

T_{rr}, I_{rr}-I_f特性<INV部>
T_{rr}, I_{rr}-I_f<INV>

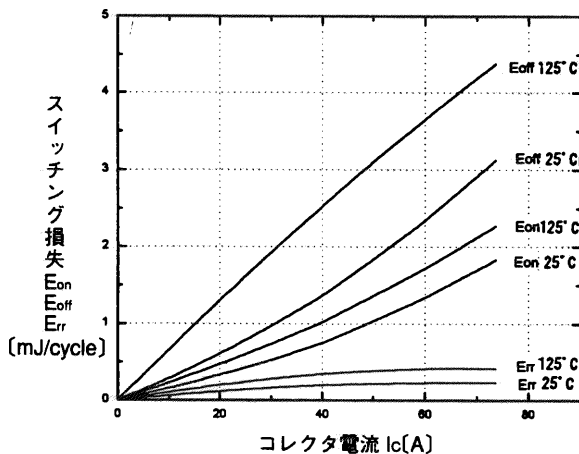

スイッチング損失-コレクタ電流特性<INV部>
Switching loss vs. Collector current<INV>

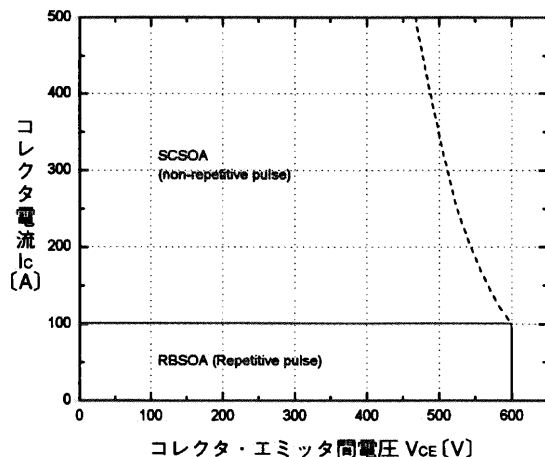

安全動作領域(逆バイアス)(T_J≦125°C)<INV部>
Reverse biased safe operating area<INV>

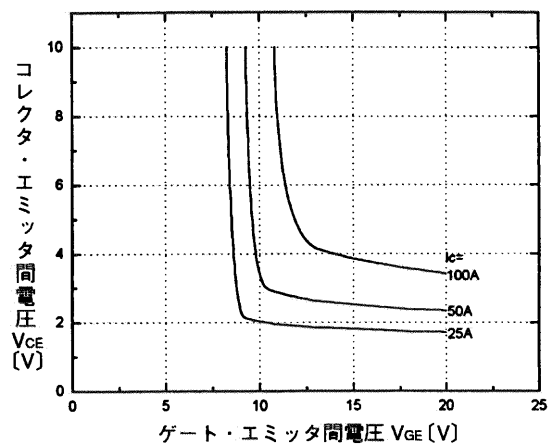
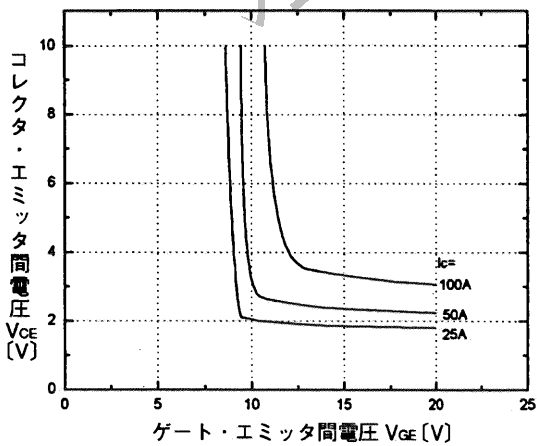
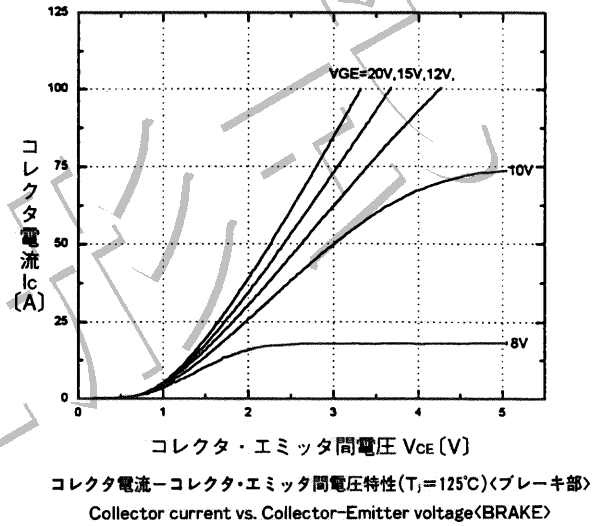
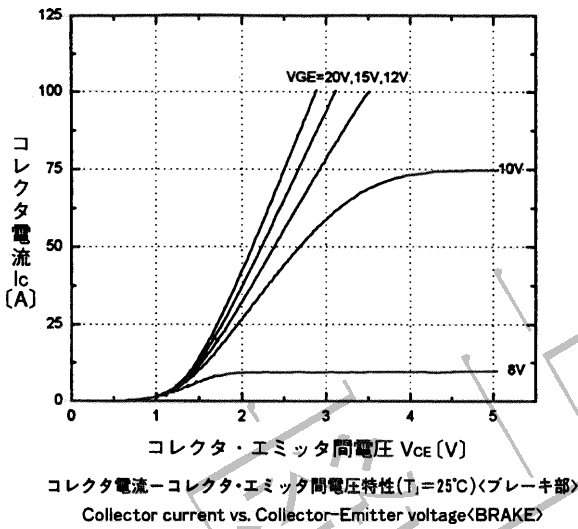
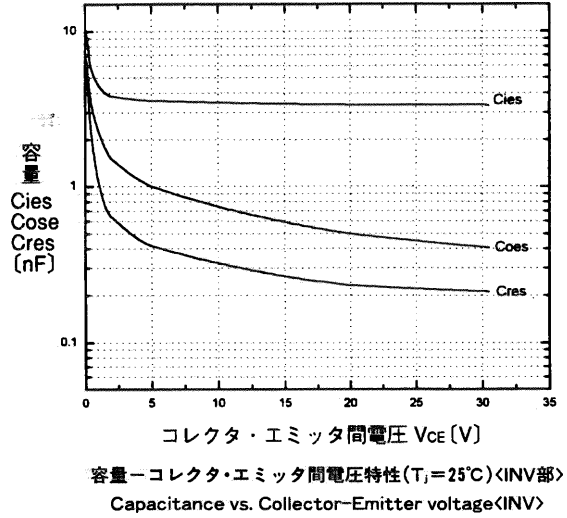
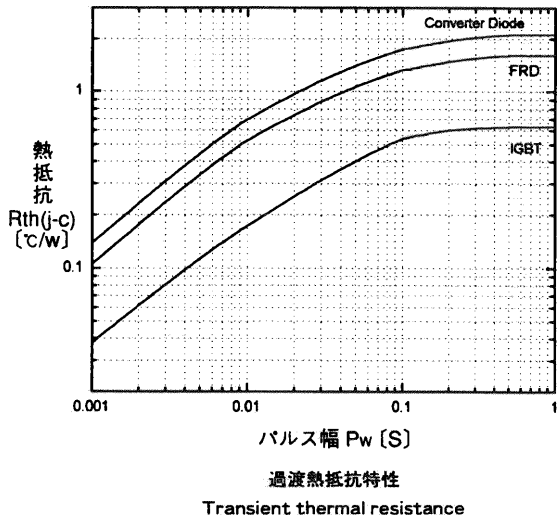

コレクタ・エミッタ間電圧-ゲート・エミッタ間電圧特性 ($T_j=25^{\circ}C$) <ブレーキ部> コレクタ・エミッタ間電圧-ゲート・エミッタ間電圧特性 ($T_j=125^{\circ}C$) <ブレーキ部>

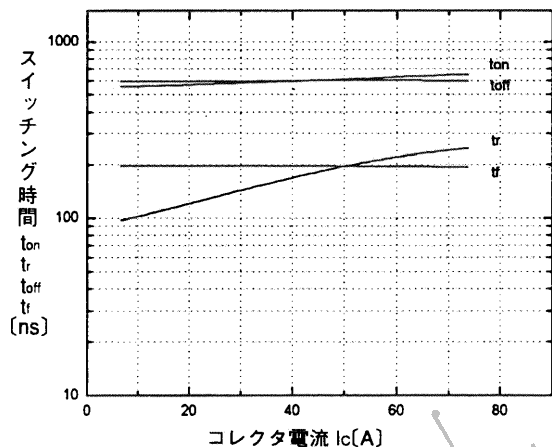

スイッチング時間-コレクタ電流特性 ($T_j=25^\circ\text{C}$)<ブレーキ部>
Switching time vs. Collector current<BRAKE>

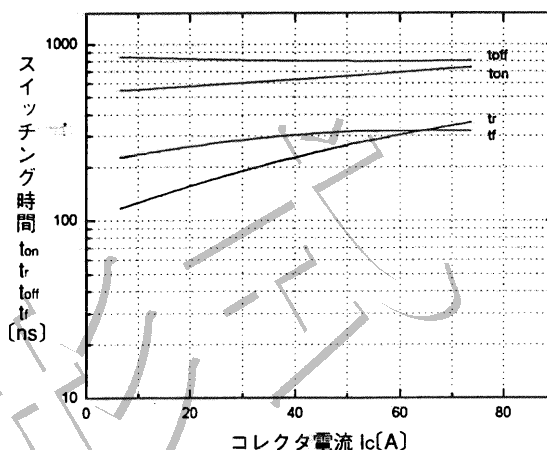

スイッチング時間-コレクタ電流特性 ($T_j=125^\circ\text{C}$)<ブレーキ部>
Switching time vs. Collector current<BRAKE>

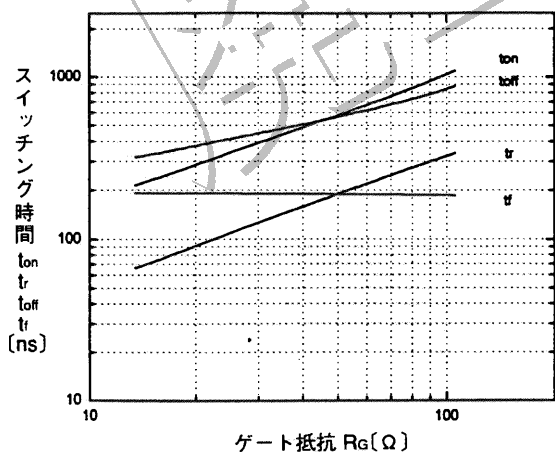

スイッチング時間-ゲート抵抗特性 ($T_j=25^\circ\text{C}$)<ブレーキ部>
Switching time vs. Gate resistance<BRAKE>

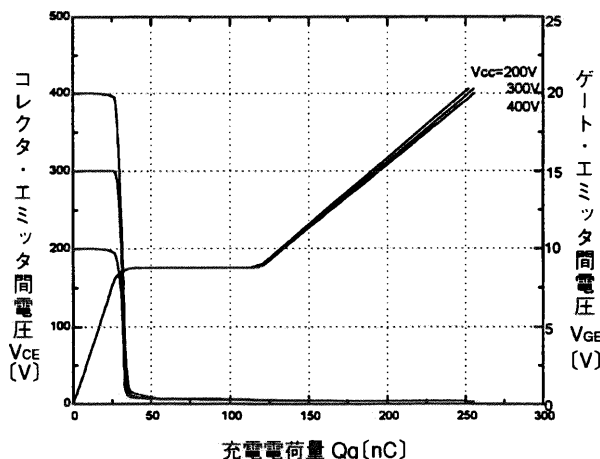

ダイナミック入力特性 ($T_j=25^\circ\text{C}$)<ブレーキ部>
Dynamic input characteristic<BRAKE>

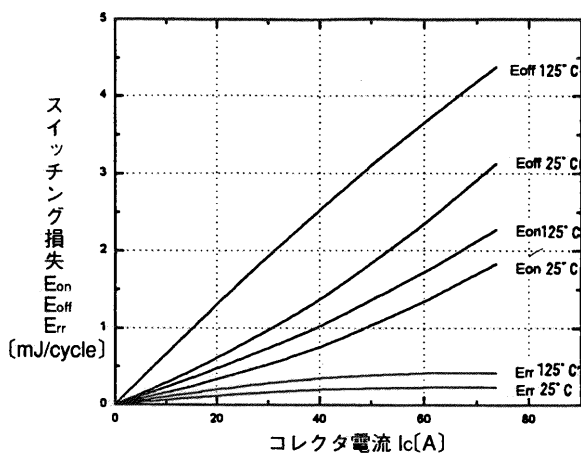

スイッチング損失-コレクタ電流特性<ブレーキ部>
Switching loss vs. Collector current<BRAKE>

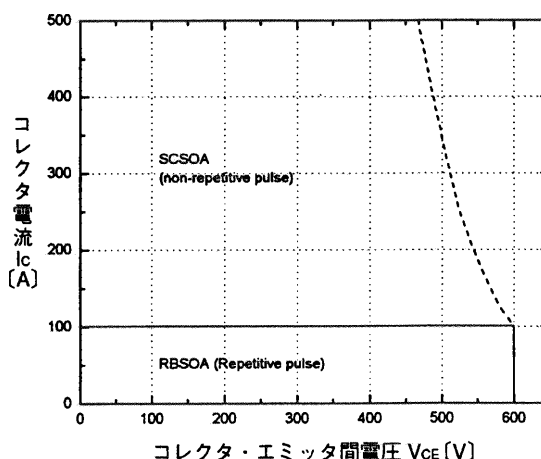

安全動作領域(逆バイアス) ($T_j \leq 125^\circ\text{C}$)<ブレーキ部>
Reverse biased safe operating area<BRAKE>

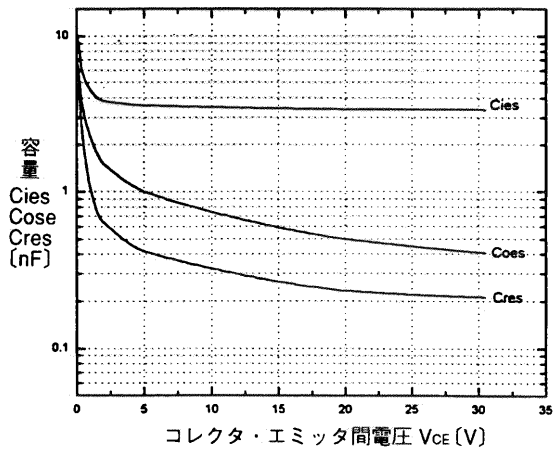

容量-コレクタ・エミッタ間電圧特性 ($T_j=25^\circ\text{C}$) <ブレーキ部>
Capacitance vs. Collector-Emitter voltage <BRAKE>

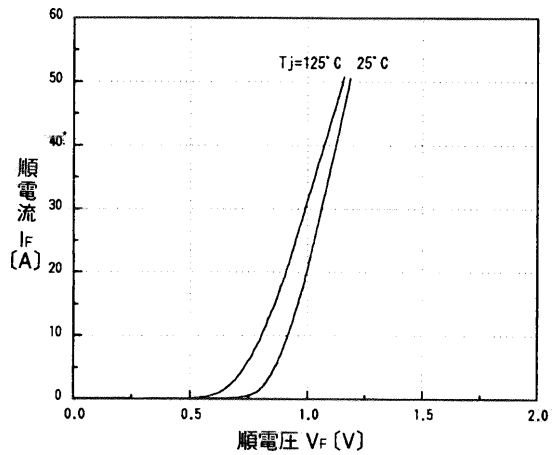

コンバータ部ダイオード順電圧特性
Converter Diode
Forward current vs. Forward voltage

■ Outline Drawings, mm

