











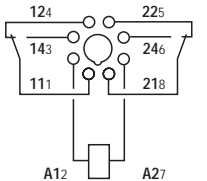
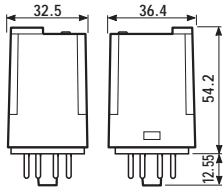
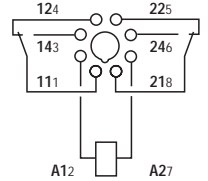
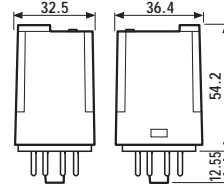
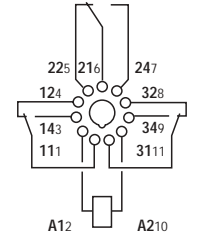
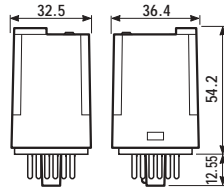





- 8 - 11 pin plug-in
- AC or DC coils
- Lockable test button with mechanical flag indicator
- Bifurcated contact option
- Sockets and accessories: see 90, 99 and 86 series

	60.12	60.12 - 0200	60.13
			
	<ul style="list-style-type: none"> - 2 pole - 8 pin - Plug-In for use with 90 series sockets 	<ul style="list-style-type: none"> - 2 bifurcated contacts, for low level switching capability - 8 pin - Plug-In for use with 90 series sockets 	<ul style="list-style-type: none"> - 3 pole - 11 pin - Plug-In for use with 90 series sockets
	 	 	 
Contact specifications			
Contact configuration	2 CO	2 CO	3 CO
Rated current/Maximum peak current A	10/20	6/10	10/20
Rated voltage/Maximum switching voltage V AC	250/400*	250/400*	250/400*
Rated load in AC1 VA	2,500	1,500	2,500
Rated load in AC15 (230 VAC) VA	500	250	500
Single phase motor rating (230 VAC) kW	0.37	0.185	0.37
Breaking capacity in DC1: 30/110/220V A	10/0.4/0.15	6/0.3/0.12	10/0.4/0.15
Minimum switching load mW (V/mA)	500 (10/5)	50 (5/5)	500 (10/5)
Standard contact material	AgNi	AgNi bifurcated contacts	AgNi
Coil specifications			
Nominal voltage (U _N)	V AC (50/60 Hz)	6 - 12 - 24 - 48 - 60 - 110 - 120 - 230 - 240 - 400	
	V DC	6 - 12 - 24 - 48 - 60 - 110 - 125 - 220	
Rated power AC/DC VA (50 Hz)/W	2.2/1.3	2.2/1.3	2.2/1.3
Operating range	AC	(0.8...1.1)U _N	(0.8...1.1)U _N
	DC	(0.8...1.1)U _N	(0.8...1.1)U _N
Holding voltage AC/DC	0.8 U _N /0.5 U _N	0.8 U _N /0.5 U _N	0.8 U _N /0.5 U _N
Must drop-out voltage AC/DC	0.2 U _N /0.1 U _N	0.2 U _N /0.1 U _N	0.2 U _N /0.1 U _N
Technical data			
Mechanical life AC/DC cycles	20 · 10 ⁶ /50 · 10 ⁶	20 · 10 ⁶ /50 · 10 ⁶	20 · 10 ⁶ /50 · 10 ⁶
Electrical life at rated load AC1 cycles	200 · 10 ³	250 · 10 ³	200 · 10 ³
Operate/release time ms	9/9	9/9	9/9
Insulation according to EN 61810-5	4 kV/3	4 kV/3	3.6 kV/3
Insulation between coil and contacts (1.2/50µs) kV	3.6	3.6	3.6
Dielectric strength between open contacts V AC	1,000	1,000	1,000
Ambient temperature range °C	-40...+70	-40...+70	-40...+70
Environmental protection	RT I	RT I	RT I
Approvals: (according to type)			
             			

* For 400 V applications, where requirements for pollution degree 2 are met.

- 8 - 11 pin plug-in
- AC or DC coils
- Lockable test button with mechanical flag indicator
- Bifurcated contact option
- Sockets and accessories: see 90, 99 and 86 series

60.13 - 0200

60.62

60.63



- 3 bifurcated contacts, for low level switching capability
- 11 pin
- Plug-In for use with 90 series sockets

- 2 pole
- Faston 187 (4.8x0.8)mm with flange mount

- 3 pole
- Faston 187 (4.8x0.8)mm with flange mount

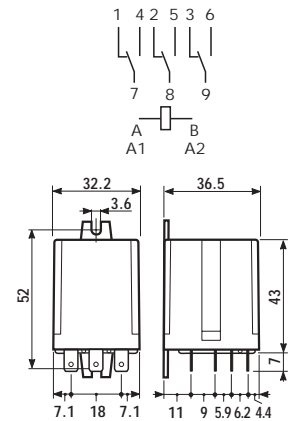
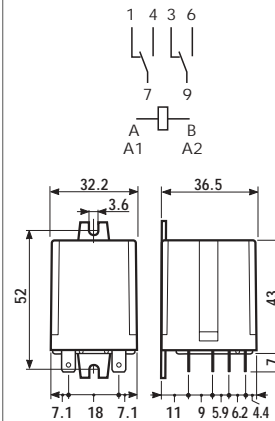
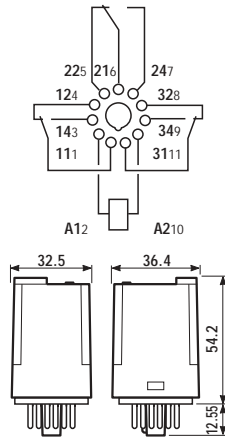

* For 400 V applications, where requirements for pollution degree 2 are met.

Contact specifications				
Contact configuration		3 CO	2 CO	3 CO
Rated current/Maximum peak current	A	6/10	10/20	10/20
Rated voltage/Maximum switching voltage	V AC	250/400*	250/400*	250/400*
Rated load in AC1	VA	1,500	2,500	2,500
Rated load in AC15 (230 VAC)	VA	250	500	500
Single phase motor rating (230 VAC)	kW	0.185	0.37	0.37
Breaking capacity in DC1: 30/110/220V	A	6/0.3/0.12	10/0.4/0.15	10/0.4/0.15
Minimum switching load	mW (V/mA)	50 (5/5)	500 (10/5)	500 (10/5)
Standard contact material		AgNi bifurcated contacts	AgNi	AgNi
Coil specifications				
Nominal voltage (U _N)	V AC (50/60 Hz)	6 - 12 - 24 - 48 - 60 - 110 - 120 - 230 - 240 - 400		
	V DC	6 - 12 - 24 - 48 - 60 - 110 - 125 - 220		
Rated power AC/DC	VA (50 Hz)/W	2.2/1.3	2.2/1.3	2.2/1.3
Operating range	AC	(0.8...1.1)U _N	(0.8...1.1)U _N	(0.8...1.1)U _N
	DC	(0.8...1.1)U _N	(0.8...1.1)U _N	(0.8...1.1)U _N
Holding voltage	AC/DC	0.8 U _N /0.5 U _N	0.8 U _N /0.5 U _N	0.8 U _N /0.5 U _N
Must drop-out voltage	AC/DC	0.2 U _N /0.1 U _N	0.2 U _N /0.1 U _N	0.2 U _N /0.1 U _N
Technical data				
Mechanical life AC/DC	cycles	20 · 10 ⁶ /50 · 10 ⁶	20 · 10 ⁶ /50 · 10 ⁶	20 · 10 ⁶ /50 · 10 ⁶
Electrical life at rated load AC1	cycles	250 · 10 ³	200 · 10 ³	200 · 10 ³
Operate/release time	ms	9/9	9/9	9/9
Insulation according to EN 61810-5		3.6 kV/3	4 kV/3	3.6 kV/3
Insulation between coil and contacts (1.2/50µs)	kV	3.6	3.6	3.6
Dielectric strength between open contacts	V AC	1,000	1,000	1,000
Ambient temperature range	°C	-40...+70	-40...+70	-40...+70
Environmental protection		RT I	RT I	RT I

Approvals: (according to type)



ORDERING INFORMATION

Example: a 60 series plug-in relay, 3 CO (3PDT) with coil rated 12 V DC, test button and mechanical indicator.

6 0 . 1 3 . 9 . 0 1 2 . 0 0 4 0

Series — 60

Type — 139

1 = 8/11 pin plug-in
6 = Faston 187 (mm 4.8x0.8) with flange mount

No. of poles — 012

2 = 2 pole
3 = 3 pole

Coil version — 9

4 = Current sensing
8 = AC (50/60 Hz)
9 = DC

Coil voltage — see coil specifications

A: Contact material

0 = Standard
2 = AgCdO
5 = AgNi + 5µm Au

B: Contact circuit

0 = CO
2 = Bifurcated contacts
60.12/13 - 6A only

C: Options

0 = None
2 = Mechanical indicator
3 = LED (AC)
4 = Lockable test button + mechanical indicator
5 = Lockable test button + LED (AC)
54 = Lockable test button + LED (AC) + mechanical indicator
6 = LED + diode (positive to pin 2, DC)
7 = Lockable test button + LED + diode (positive to pin 2)
74 = Lockable test button + LED + diode (positive to pin 2) + mechanical indicator

D: Special versions

0 = Standard

Only combinations in the same row are possible

Preferred versions

	coil version	A	B	C	D
60.12/13	AC/DC	0	0	4	0
60.62/63	AC/DC	0	0	0	0

All versions

	coil version	A	B	C	D
60.12/13	AC	0 - 2	0	0 - 2 - 3 - 4 - 5	0
	AC	0 - 2	0	54	/
	AC	5	0 - 2	0 - 2 - 3 - 4 - 5	0
	AC	5	0 - 2	54	/
	DC	0 - 2	0	0 - 2 - 4 - 6 - 7	0
	DC	0 - 2	0	74	/
	DC	5	0 - 2	0 - 2 - 4 - 6 - 7	0
	DC	5	0 - 2	74	/
	current sensing	0	0	4	0
60.62/63	AC/DC	0 - 2 - 5	0	0	0

POSSIBLE OPTIONS

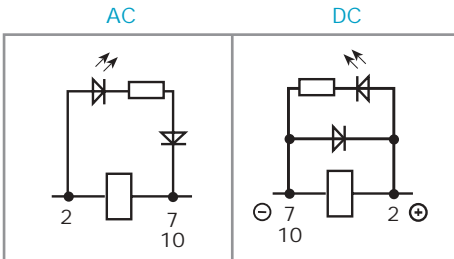

- Option = 0030
0050
0054
- Option = 0060
0070
0074



LOCKABLE TEST BUTTON AND MECHANICAL FLAG INDICATOR (0040)

The dual-purpose Finder test button can be used in two ways:

Case 1) The plastic pip (located directly above the test button) remains intact. In this case, when the test button is pushed, the contacts operate. When the test button is released the contacts return to their former state.

Case 2) The plastic pip is broken-off (using an appropriate cutting tool). In this case, (in addition to the above function), when the test button is pushed and rotated, the contacts are latched in the operating state, and remain so until the test button is rotated back to its former position.

In both cases ensure that the test button actuation is swift and decisive.

ACCESSORIES

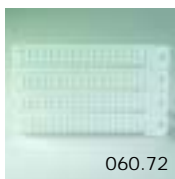

Sheet of marker tags for relay types 60.12 and 60.13 (72 tags):
6x12mm

060.72

TECHNICAL DATA

INSULATION

INSULATION according to EN 61810-5	insulation rated voltage	V	250
	rated impulse withstand voltage	kV	4 (2 pole) 3.6 (3 pole)
	pollution degree		3
	overvoltage category		III

60 IMMUNITY

CONDUCTED DISTURBANCE IMMUNITY	BURST (according to EN 61000-4-4) level 4 (4kV)
	SURGE (according to EN 61000-4-5) level 4 (4kV)

OTHER DATA

BOUNCE TIME: NO/NC	ms	2/4		
VIBRATION RESISTANCE (10...55Hz): NO/NC	g/g	5/3		
POWER LOST TO THE ENVIRONMENT		2 CO	3 CO	
	without contact current	W	1.3	1.3
	with rated current	W	2.7	3.4

CONTACT SPECIFICATIONS

F 60

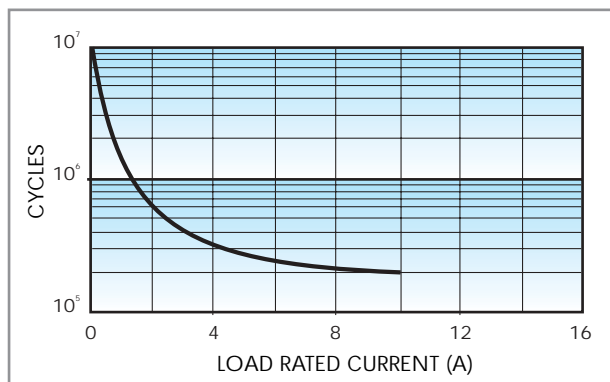

Electrical life vs AC1 load.

H 60

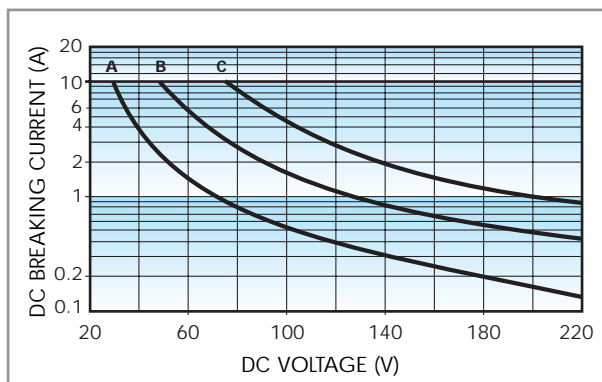

Breaking capacity for DC1 load.

- A** = Load applied to 1 contact
- B** = Load applied to 2 contacts in series
- C** = Load applied to 3 contacts in series

- When switching a resistive load (DC1) having voltage and current values under the curve the expected electrical life is $\geq 100 \cdot 10^3$ cycles.
 - In case of DC13 loads the connection of a diode in parallel with the load will permit the same electrical life as for a DC1 load.
- Note:** the release time of load will be increase.

COIL SPECIFICATIONS

DC VERSION DATA

Nominal voltage U_N V	Coil code	Operating range		Resistance R Ω	Rated coil consumption I at U_N mA
		U_{min} V	U_{max} V		
6	9.006	4.8	6.6	28	214
12	9.012	9.6	13.2	110	109
24	9.024	19.2	26.4	445	53.9
48	9.048	38.4	52.8	1,770	27.1
60	9.060	48	66	2,760	21.7
110	9.110	88	121	9,420	11.7
125	9.125	100	137.5	12,000	10.4
220	9.220	176	242	37,300	5.8

AC VERSION DATA

Nominal voltage U_N V	Coil code	Operating range		Resistance R Ω	Rated coil consumption I at U_N (50Hz) mA
		U_{min} V	U_{max} V		
6	8.006	4.8	6.6	4.6	367
12	8.012	9.6	13.2	19	183
24	8.024	19.2	26.4	74	90
48	8.048	38.4	52.8	290	47
60	8.060	48	66	450	37
110	8.110	88	121	1,600	20
120	8.120	96	132	1,940	18.6
230	8.230	184	253	7,250	10.5
240	8.240	192	264	8,500	9.2
400	8.400	320	440	19,800	6

R 60 DC

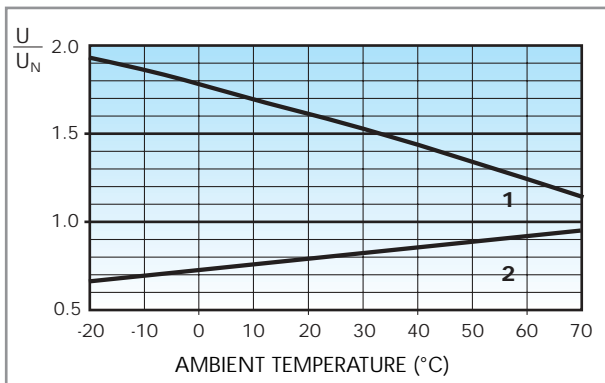

Operating range (DC version) vs ambient temperature.
1 - Max coil voltage permitted.
2 - Min pick-up voltage with coil at ambient temperature.

R 60 AC

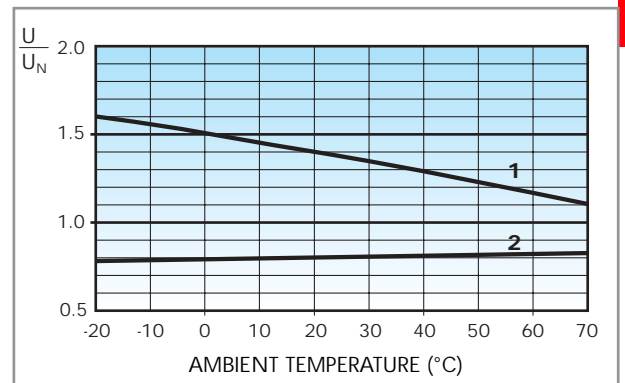

Operating range (AC version) vs ambient temperature.
1 - Max coil voltage permitted.
2 - Min pick-up voltage with coil at ambient temperature.

CURRENT SENSING VERSION

Wiring Diagram

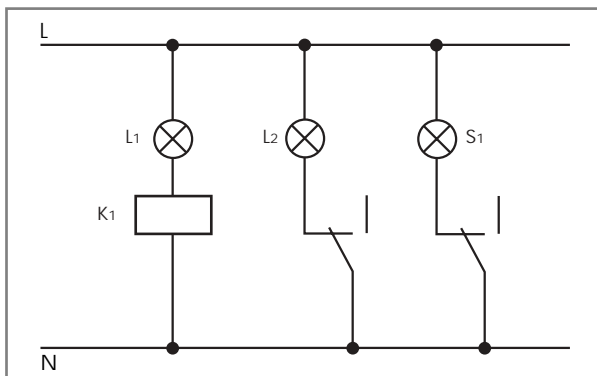

Typical application with current sensing relays.
 An open circuit filament of lamp L1 is detected by the current sensing relay coil (K1) which causes the back-up safety lamp L2 to be energised, and indication of failure at the control panel via lamp S1.

Example: navigation light.

- L1 = Light
- L2 = Safety light
- S1 = Control light
- K1 = Relay

60 Series - CURRENT SENSING AC

Coil code	I_{min} (A)	I_N (A)	I_{max} (A)	R (Ω)
4251	2.1	2.5	3.0	0.05
4181	1.5	1.8	2.2	0.10
4161	1.4	1.6	1.9	0.12
4121	1.0	1.2	1.4	0.22
4101	0.85	1.0	1.2	0.32
4051	0.42	0.5	0.6	1.28
4041	0.34	0.4	0.5	2.00
4031	0.25	0.3	0.4	3.57
4021	0.17	0.2	0.25	8.0
4011	0.085	0.1	0.15	32.1

60 Series - CURRENT SENSING DC

Coil code	I_{min} (A)	I_N (A)	I_{max} (A)	R (Ω)
4202	1.7	2.0	2.4	0.15
4182	1.5	1.8	2.2	0.19
4162	1.4	1.6	1.9	0.24
4142	1.2	1.4	1.7	0.31
4122	1.0	1.2	1.4	0.42
4102	0.85	1.0	1.2	0.61
4092	0.8	0.9	1.1	0.75
4062	0.5	0.6	0.7	1.70
4032	0.25	0.3	0.4	6.70
4012	0.085	0.1	0.15	61

Other types of current sensing relays are available on request.



90.03

Approvals
(according to type):



- Double terminal A1 (for easy start connection).
- RATED VALUES: 10 A - 250 V
- DIELECTRIC STRENGTH: ≥ 2 kV AC
- PROTECTION CATEGORY: IP 20
- AMBIENT TEMPERATURE: (-40...+70)°C
- TORQUE: 0.6 Nm
- WIRE STRIP LENGTH: 10 mm
- MAX WIRE SIZE:

	solid wire	stranded wire
mm ²	1x6 / 2x2.5	1x4 / 2x2.5
AWG	1x10 / 2x14	1x12 / 2x14

Relay type	60.12		60.13	
	BLUE	BLACK	BLUE	BLACK
Colour	BLUE	BLACK	BLUE	BLACK
Clamp terminal socket: panel or 35 mm rail (EN 50022) mount	90.02	90.02.0	90.03	90.03.0
Metal retaining clip	090.33			
Modules (see table below)	99.02			
Timer module	86.00, 86.10, 86.20			
6-way jumper link for 90.02 and 90.03 sockets	090.06			

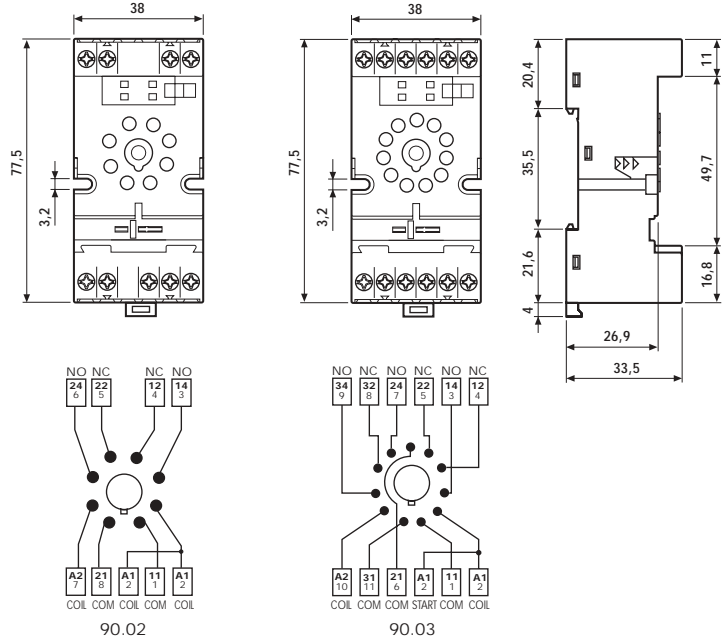

FOR 90.02 AND 90.03 SOCKETS:



090.06

6-way jumper link	090.06
--------------------------	--------

- RATED VALUES: 10 A - 250 V

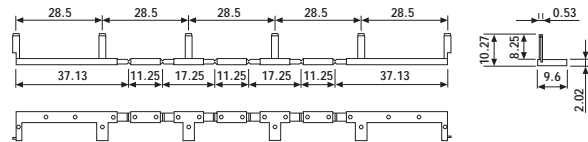

86.00

86 Series Module Timers (see technical data pages 126/131)	
Multi-voltage: 12...240 V AC/DC;	
Multi-functions: AI, DI, SW, BE, CE, DE, EE, FE; (0.05s...100h)	86.00.0.240.0000
Mono-function: 12...24 V AC/DC; function AI; (1.5s...60min)	86.10.0.024.0000
Mono-function: 12...24 V AC/DC; function DI; (1.5s...60min)	86.20.0.024.0000



99.02

Approvals
(according to type):



* Modules in Black housing are available on request.

**For DC supply, apply the positive to terminal A1.

99.02 coil indication and EMC suppression modules (see technical data page 179)		BLUE*
Diode** (+A1, standard polarity)	(6...220) V DC	99.02.3.000.00
Diode (+A2, non standard polarity)	(6...220) V DC	99.02.2.000.00
LED	(6...24) V DC/AC	99.02.0.024.59
LED	(28...60) V DC/AC	99.02.0.060.59
LED	(110...240) V DC/AC	99.02.0.230.59
LED + Diode** (+A1, standard polarity)	(6...24) V DC	99.02.9.024.99
LED + Diode** (+A1, standard polarity)	(28...60) V DC	99.02.9.060.99
LED + Diode** (+A1, standard polarity)	(110...220) V DC	99.02.9.220.99
LED + Diode (+A2, non standard polarity)	(6...24) V DC	99.02.9.024.79
LED + Diode (+A2, non standard polarity)	(28...60) V DC	99.02.9.060.79
LED + Diode (+A2, non standard polarity)	(110...220) V DC	99.02.9.220.79
LED + Varistor	(6...24) V DC/AC	99.02.0.024.98
LED + Varistor	(28...60) V DC/AC	99.02.0.060.98
LED + Varistor	(110...240) V DC/AC	99.02.0.230.98
RC circuit	(6...24) V DC/AC	99.02.0.024.09
RC circuit	(28...60) V DC/AC	99.02.0.060.09
RC circuit	(110...240) V DC/AC	99.02.0.230.09
Residual current by-pass (62 k Ω /1W)	(110...240) V AC	99.02.8.230.07



90.21

Approvals
(according to type):



- RATED VALUES: 10 A - 250 V
- DIELECTRIC STRENGTH: ≥ 2 kV AC
- PROTECTION CATEGORY: IP 20
- AMBIENT TEMPERATURE: (-40...+70)°C
- SCREW TORQUE: 0.5 Nm
- WIRE STRIP LENGTH: 10 mm
- MAX WIRE SIZE:

	solid wire	stranded wire
mm ²	1x6 / 2x2.5	1x6 / 2x2.5
AWG	1x10 / 2x14	1x10 / 2x14

Relay type	60.12		60.13	
Colour	BLUE	BLACK	BLUE	BLACK
Clamp terminal socket: panel or 35 mm rail (EN 50022) mount retaining clip 090.33 supplied with socket packaging code SMA	90.20	90.20.0	90.21	90.21.0
Retaining clip	090.33			
Modules (see table below)	99.01			

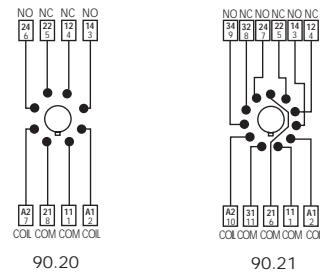
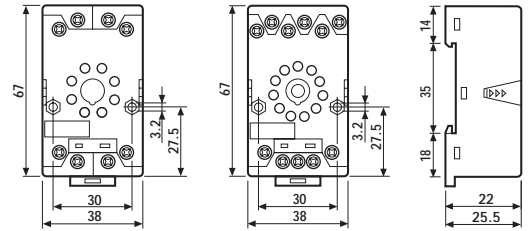

60

FOR 90.20 AND 90.21 SOCKETS:



99.01

Approvals
(according to type):

GOST

* Modules in Black housing are available on request.

**For DC supply, apply the positive to terminal A1.

Green LED is standard. Red LED available on request.

99.01 coil indication and EMC suppression modules (see technical data page 179)		BLUE*
Diode** (+A1, standard polarity)	(6...220) V DC	99.01.3.000.00
Diode (+A2, non standard polarity)	(6...220) V DC	99.01.2.000.00
LED	(6...24) V DC/AC	99.01.0.024.59
LED	(28...60) V DC/AC	99.01.0.060.59
LED	(110...240) V DC/AC	99.01.0.230.59
LED + Diode** (+A1, standard polarity)	(6...24) V DC	99.01.9.024.99
LED + Diode** (+A1, standard polarity)	(28...60) V DC	99.01.9.060.99
LED + Diode** (+A1, standard polarity)	(110...220) V DC	99.01.9.220.99
LED + Diode (+A2, non standard polarity)	(6...24) V DC	99.01.9.024.79
LED + Diode (+A2, non standard polarity)	(28...60) V DC	99.01.9.060.79
LED + Diode (+A2, non standard polarity)	(110...220) V DC	99.01.9.220.79
LED + Varistor	(6...24) V DC/AC	99.01.0.024.98
LED + Varistor	(28...60) V DC/AC	99.01.0.060.98
LED + Varistor	(110...240) V DC/AC	99.01.0.230.98
RC circuit	(6...24) V DC/AC	99.01.0.024.09
RC circuit	(28...60) V DC/AC	99.01.0.060.09
RC circuit	(110...240) V DC/AC	99.01.0.230.09
Residual current by-pass (62 kΩ/1W)	(110...240) V AC	99.01.8.230.07



90.23

Relay type	60.12	60.13
Colour	BLUE	BLUE
Clamp terminal socket: panel or 35 mm rail (EN 50022) mount (retaining clip 090.33 supplied with socket packaging code SMA)	90.22	90.23
Metal retaining clip	090.33	

Homologations
(suivant les types):



- RATED VALUES: 10 A - 250 V
- DIELECTRIC STRENGTH: ≥ 2 kV AC
- PROTECTION CATEGORY: IP 20
- AMBIENT TEMPERATURE: (-40...+70)°C
- SCREW TORQUE: 0.5 Nm
- WIRE STRIP LENGTH: 7 mm
- MAX WIRE SIZE:

	fil rigide	fil flexible
mm ²	1x6 / 2x2.5	1x6 / 2x2.5
AWG	1x10 / 2x14	1x10 / 2x14

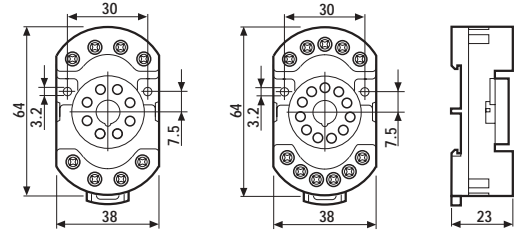

90.22

90.23

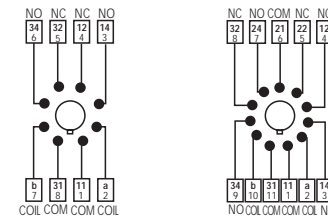

90.22

90.23



90.26

Relay type	60.12		60.13	
Colour	BLUE	BLACK	BLUE	BLACK
Screw terminal socket: panel or 35 mm rail (EN 50022) mount retaining clip 090.33 supplied with socket packaging code SMA	90.26	90.26.0	90.27	90.27.0
Metal retaining clip	090.33			

Approvals
(according to type):



- RATED VALUES: 10 A - 250 V
- DIELECTRIC STRENGTH: ≥ 2 kV AC
- PROTECTION CATEGORY: IP 20
- AMBIENT TEMPERATURE: (-40...+70)°C
- SCREW TORQUE: 0.8 Nm
- WIRE STRIP LENGTH: 10 mm
- MAX WIRE SIZE:

	solid wire	stranded wire
mm ²	1x4 / 2x2.5	1x4 / 2x2.5
AWG	1x12 / 2x14	1x12 / 2x14

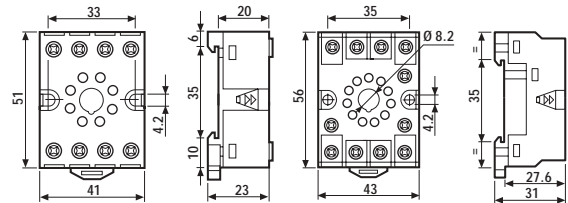

90.26

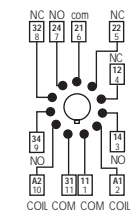

90.27



90.12

Relay type	60.12	60.13
Colour	BLACK	BLACK
Flange mount solder socket mount with M3 screw	90.12	90.13

Approvals
(according to type):



- RATED VALUES: 10 A - 250 V
- DIELECTRIC STRENGTH: ≥ 2 kV AC
- AMBIENT TEMPERATURE: (-40...+70)°C

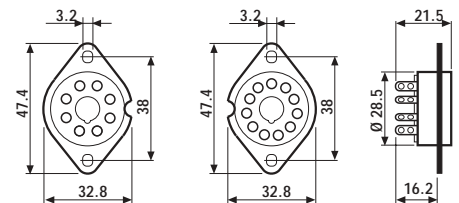

90.12

90.13



Relay type	60.12	60.13
P.C.B. socket	BLUE 90.14	90.15
	BLUE 90.14.1 (Ø 17.5mm)	90.15.1 (Ø 19mm)

Approvals
(according to type):



- RATED VALUES: 10 A - 250 V
- DIELECTRIC STRENGTH: ≥ 2 kV AC
- AMBIENT TEMPERATURE: (-40...+70)°C

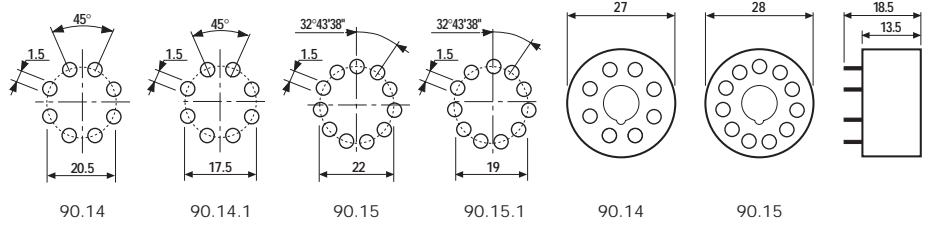

PACKAGING CODES

How to code and identify retaining clip and packaging options for sockets.

Code options according to the last three letters:

9	0	.	2	1	S	M	A
---	---	---	---	---	---	---	---

A → Standard packaging
 SM → Metal retaining clip
 SX → No retaining clip