

SKiiP 82 AHB 15

| Absolute Maximum Ratings | | Values | Units |
|------------------------------------|---|----------------|------------------|
| Symbol | Conditions ¹⁾ | | |
| Bridge Rectifier | | | |
| V _{RRM} | | 1500 | V |
| I _D | T _{heatsink} = 80 °C | 75 | A |
| I _{FSM} /I _{TSM} | t _p = 10 ms; sin. 180 °C, T _j = 25 °C | 1000 | A |
| I _{pt} | t _p = 10 ms; sin. 180 °C, T _j = 25 °C | 5000 | A ² s |
| IGBT Chopper | | | |
| V _{CEs} | | 1200 | V |
| V _{GEs} | | ± 20 | V |
| I _C | T _{heatsink} = 25 / 80 °C | 65 / 45 | A |
| I _{CM} | t _p < 1 ms; T _{heatsink} = 25 / 80 °C | 130 / 90 | A |
| Freewheeling Diode ²⁾ | | | |
| V _{RRM} | | 1200 | V |
| I _F | T _{heatsink} = 25 / 80 °C | 38 / 26 | A |
| I _{FM} | t _p < 1 ms; T _{heatsink} = 25 / 80 °C | 76 / 52 | A |
| T _j | Diode & IGBT | - 40 ... + 150 | °C |
| T _j | Thyristor | - 40 ... + 125 | °C |
| T _{stg} | | - 40 ... + 125 | °C |
| V _{isol} | AC, 1 min. | 2500 | V |

| Characteristics | | min. | typ. | max. | Units |
|------------------------------------|--|--|----------|----------|-------|
| Symbol | Conditions ¹⁾ | | | | |
| Diode - Rectifier | | | | | |
| V _F | I _F = 75 A T _j = 125 °C | - | 1,15 | - | V |
| V _{TO} | T _j = 125 °C | - | 0,8 | - | V |
| r _T | T _j = 125 °C | - | 4,5 | - | mΩ |
| R _{thjh} | per diode | - | - | 1,0 | K/W |
| Thyristor - Rectifier | | | | | |
| V _T | I _F = 120 A T _j = 25 °C | - | - | 1,8 | V |
| V _T (TO) | T _j = 125 °C | - | - | 1,1 | V |
| r _T | T _j = 125 °C | - | - | 5 | mΩ |
| R _{thjh} | per thyristor | - | - | 0,9 | K/W |
| I _{GD} | T _j = 125 °C | 5 | - | - | mA |
| V _{GT} | T _j = 25 °C | - | - | 3 | V |
| I _{GT} | | - | - | 150 | mA |
| I _H | T _j = 25 °C | - | 250 | - | mA |
| I _L | | - | 600 | - | mA |
| dv/dt _{CR} | T _j = 125 °C | 500 | - | - | V/μs |
| di/dt _{CR} | | - | - | 125 | A/μs |
| IGBT - Chopper | | | | | |
| V _{CEsat} | I _C = 50 A T _j = 25 (125) °C | - | 2,5(3,1) | 3,0(3,7) | V |
| t _{d(on)} | V _{CC} = 600 V; V _{GE} = ± 15 V | - | 44 | 100 | ns |
| t _r | | I _C = 50 A; T _j = 125 °C | - | 56 | 100 |
| t _{d(off)} | R _{gon} = R _{goff} = 22 Ω | - | 380 | 500 | ns |
| t _f | | inductive load | - | 70 | 100 |
| E _{on} + E _{off} | | - | 13 | - | mJ |
| C _{ies} | V _{CE} = 25 V; V _{GE} = 0 V, 1 MHz | - | 3,3 | - | nF |
| R _{thjh} | per IGBT | - | - | 0,5 | K/W |

MiniSKiiP 8
SEMIKRON integrated intelligent Power
SKiiP 82 AHB 15
half controlled
3-phase bridge rectifier + IGBT braking chopper

Case M8a

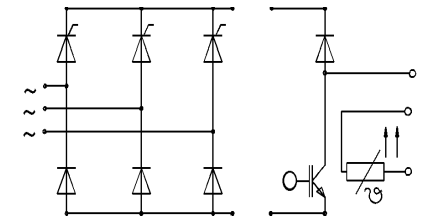
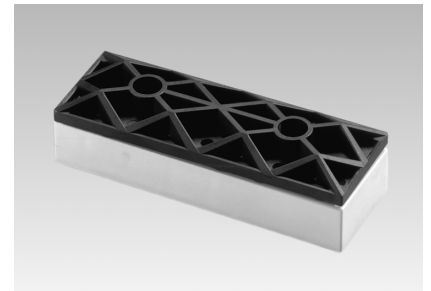

UL recognized file no. E63532

- specification of temperature sensor see part A
- common characteristics see page B 16 – 4

Options

- also available with uncontrolled rectifier (called 82 ANB 15)
- also available with powerful chopper, for characteristics please refer to SKiiP 82 AC 12
- also available with full controlled rectifier (called 82 ATB 15)

¹⁾ T_{heatsink} = 25 °C, unless otherwise specified
²⁾ CAL = Controlled Axial Lifetime Technology (soft and fast recovery)

MiniSKiP 8
SEMIKRON integrated
intelligent Power
SKiP 82 AHB 15
half controlled
3-phase bridge rectifier +
IGBT braking chopper

Case M8a

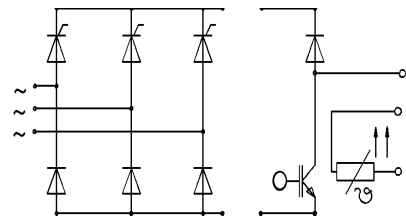
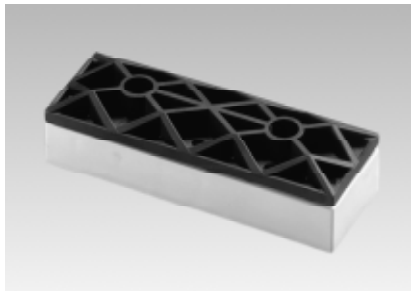

SKiP 82 AHB 15

| Characteristics | | min. | typ. | max. | Units |
|------------------------------------|---|------|-------------|----------|---------------|
| Symbol | Conditions ¹⁾ | | | | |
| Diode ²⁾ - Freewheeling | | | | | |
| $V_F = V_{EC}$ | $I_F = 25 \text{ A}$ $T_j = 25 \text{ (125) } ^\circ\text{C}$ | – | 2,0(1,8) | 2,5(2,3) | V |
| V_{TO} | $T_j = 125 ^\circ\text{C}$ | – | 1,0 | 1,2 | V |
| r_T | $T_j = 125 ^\circ\text{C}$ | – | 32 | 44 | m Ω |
| I_{RRM} | $I_F = 25 \text{ A}; V_R = -600 \text{ V}$ $di_F/dt = -500 \text{ A}/\mu\text{s}$ $V_{GE} = 0 \text{ V}, T_j = 125 ^\circ\text{C}$ per diode | – | 25 | – | A |
| Q_{rr} | | – | 4,5 | – | μC |
| E_{off} | | – | 1,0 | – | mJ |
| R_{thjh} | | – | – | 1,2 | K/W |
| Temperature Sensor | | | | | |
| R_{TS} | $T = 25 / 100 ^\circ\text{C}$ | | 1000 / 1670 | | Ω |
| Mechanical Data | | | | | |
| M_1 | case to heatsink, SI Units | 2,5 | – | 3,5 | Nm |
| Case | mechanical outline see pages B 16 –13 and B 16 – 14 | | M8a | | |

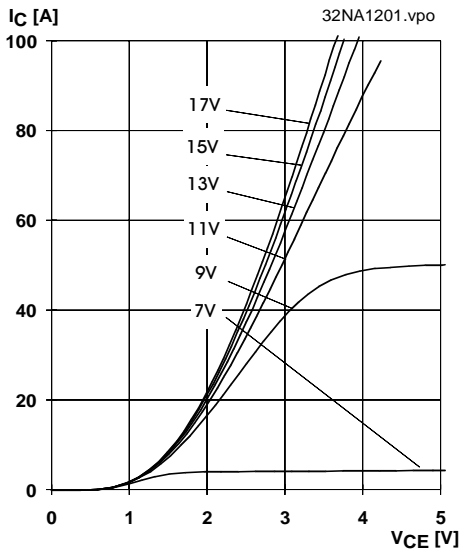

Fig. 1 Typ. output characteristic, $t_p = 80 \mu s$; $25^\circ C$

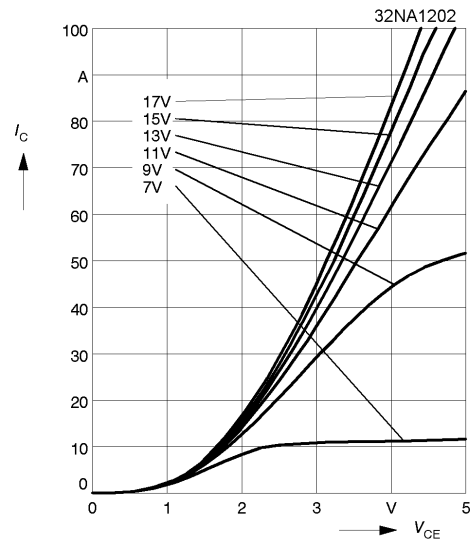

Fig. 2 Typ. output characteristic, $t_p = 80 \mu s$; $125^\circ C$

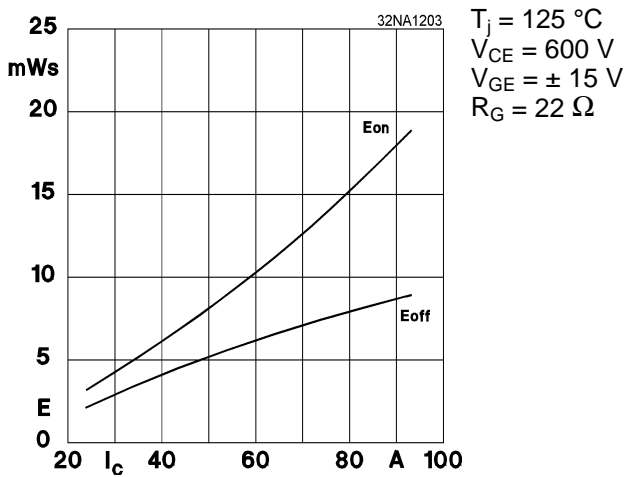

Fig. 3 Turn-on /-off energy = $f(I_C)$

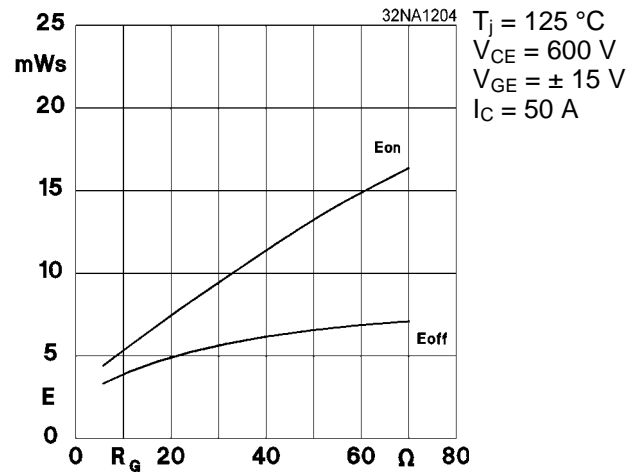

Fig. 4 Turn-on /-off energy = $f(R_G)$

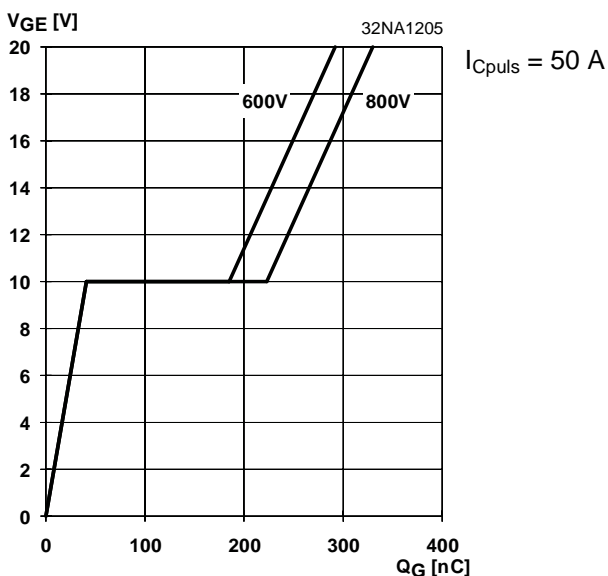

Fig. 5 Typ. gate charge characteristic

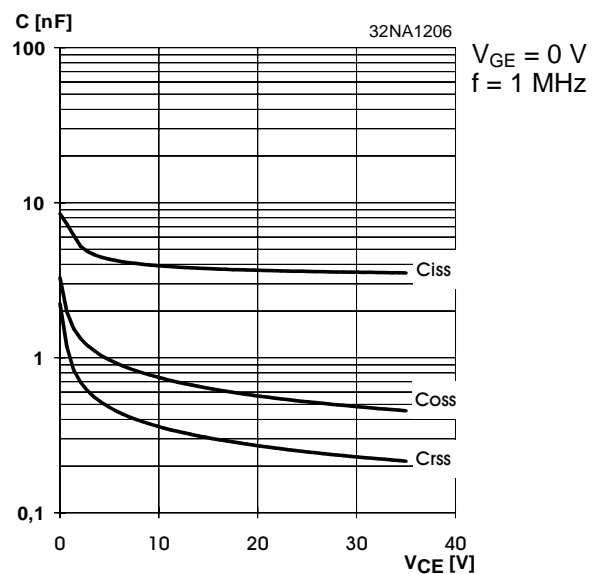

Fig. 6 Typ. capacitances vs. V_{CE}

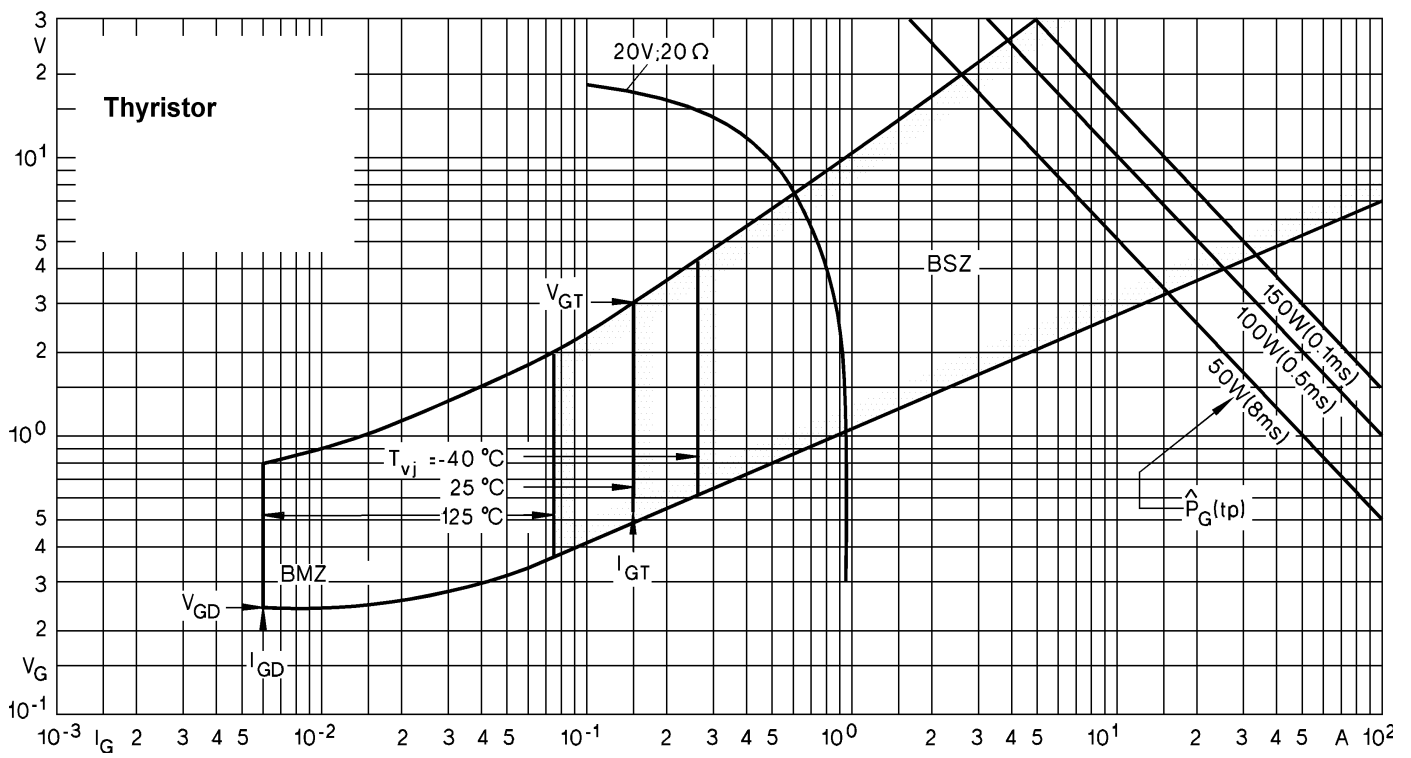

Fig. 7 Gate trigger characteristics

MiniSKiiP 1200 V

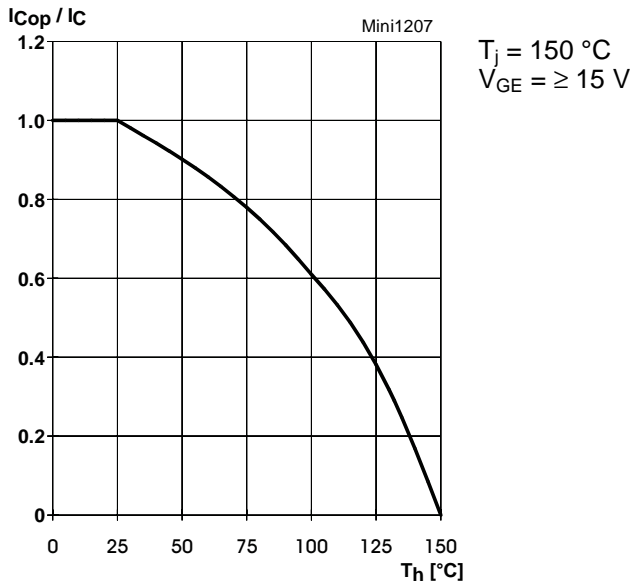

Fig. 7 Rated current of the IGBT $I_{COp} / I_C = f(T_h)$

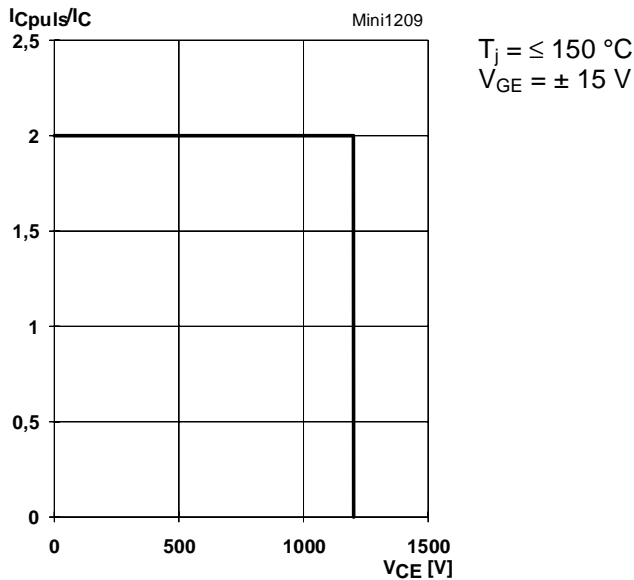

Fig. 9 Turn-off safe operating area (RBSOA) of the IGBT

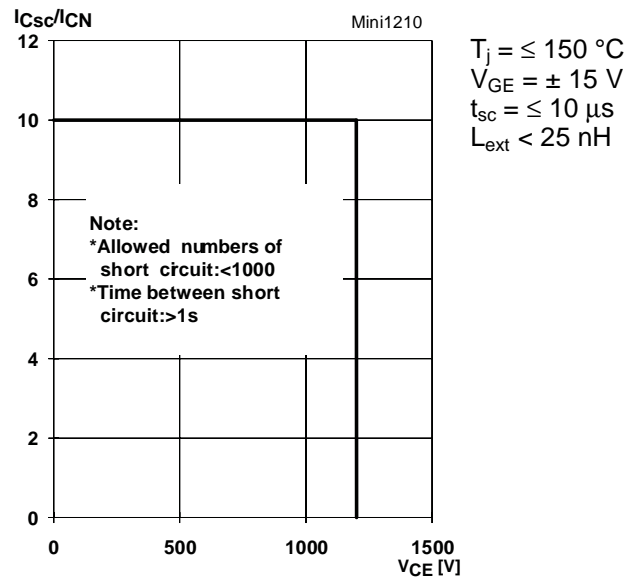

Fig. 10 Safe operating area at short circuit of the IGBT

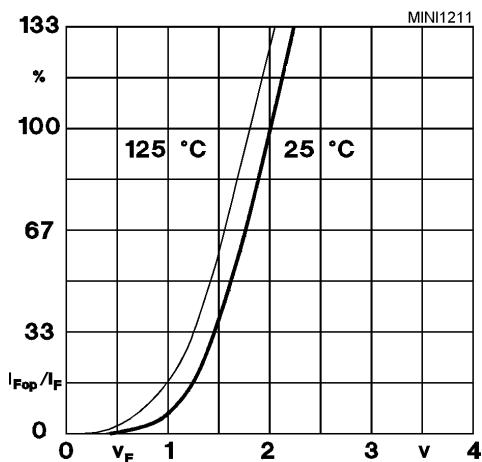

Fig. 11 Typ. freewheeling diode forward characteristic

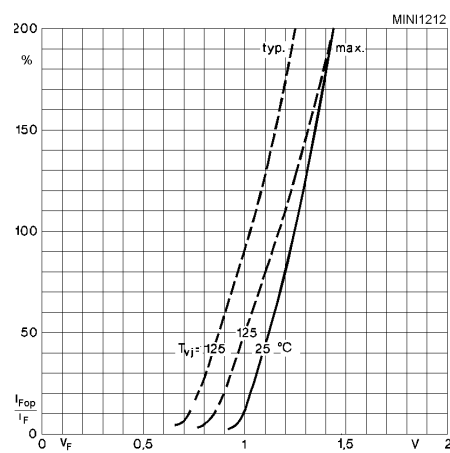

Fig. 12 Forward characteristic of the input bridge diode

MiniSKiiP 8

Input bridge part

- SKiiP 82 ANB 08
- SKiiP 83 ANB 08
- SKiiP 81 ANB 15
- SKiiP 82 ANB 15
- SKiiP 83 ANB 15
- SKiiP 83 AHB 15
- SKiiP 83 ATB 15

Circuit ANB
Case M8a

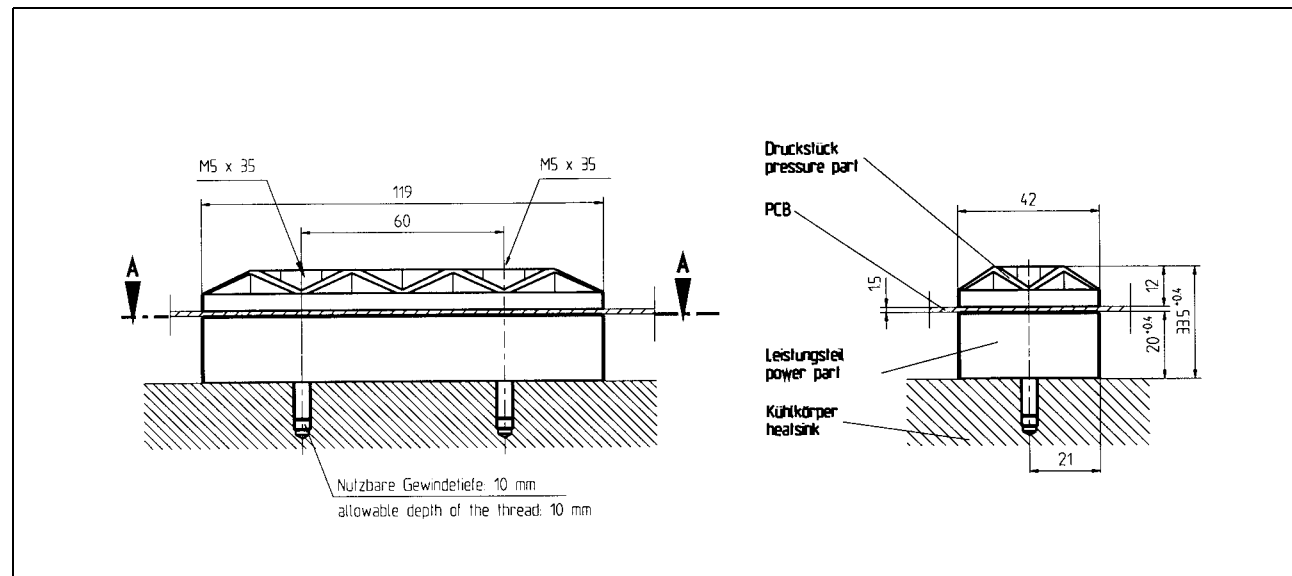
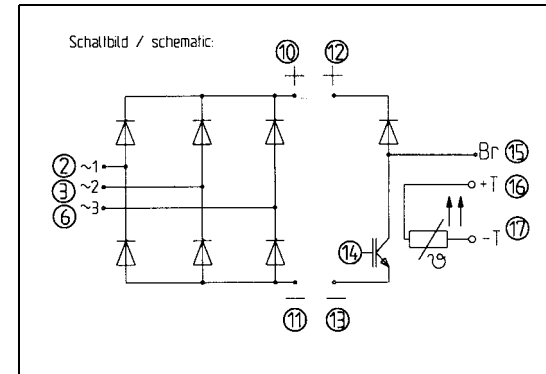

MiniSKiiP 8

Input bridge part

SKiiP 82 ANB 08
 SKiiP 83 ANB 08
 SKiiP 81 ANB 15
 SKiiP 82 ANB 15
 SKiiP 83 ANB 15
 SKiiP 83 AHB 15
 SKiiP 83 ATB 15

Case M8a
 Layout and connections for the
 customer's printed circuit board

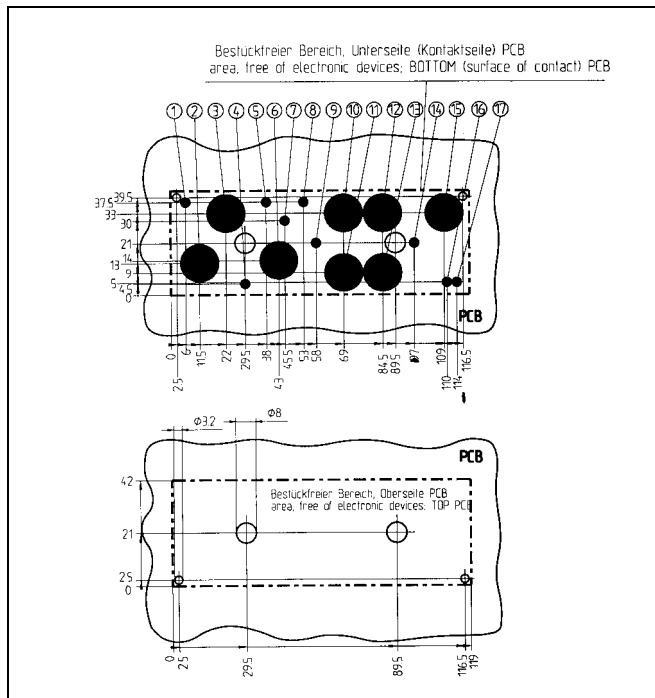

Circuit AHB

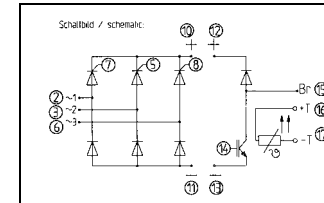

Circuit ATB

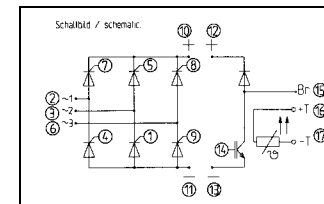

| Pin | Connection | | | |
|-----|------------------|--------------------|----------------------|---------|
| | Diode bridge ANB | Halfcontrolled AHB | Thyristor bridge ATB | |
| 1 | reserved | reserved | | G2 Bot |
| 2 | ~ 1 | ~ 1 | ~ 1 | |
| 3 | ~ 2 | ~ 2 | ~ 2 | |
| 4 | reserved | reserved | | G1 Bot |
| 5 | reserved | G2 Top | | G2 Top |
| 6 | ~ 3 | ~ 3 | ~ 3 | |
| 7 | reserved | G1 Top | | G1 Top |
| 8 | reserved | G3 Top | | G3 Top |
| 9 | reserved | reserved | | G3 Bot |
| 10 | + | + | + | |
| 11 | - | - | - | |
| 12 | + | + | + | |
| 13 | - | - | - | |
| 14 | Gate Br | Gate Br | Gate Br | Gate Br |
| 15 | Br | Br | Br | |
| 16 | T + | T + | T + | |
| 17 | T - | T - | T - | |