

Thyristor Module

$$V_{RRM} = 2 \times 1600 \text{ V}$$

$$I_{TAV} = 260 \text{ A}$$

$$V_T = 1.06 \text{ V}$$

Phase leg

Part number

MCMA260PD1600YB

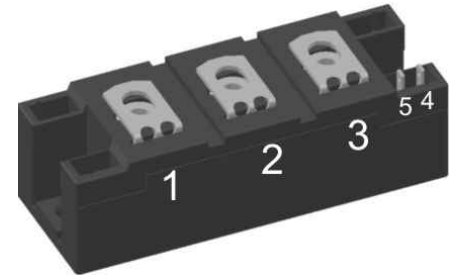

Backside: isolated

 E72873

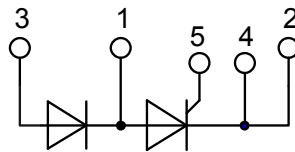

Features / Advantages:

- Thyristor for line frequency
- Planar passivated chip
- Long-term stability
- Direct Copper Bonded Al₂O₃-ceramic

Applications:

- Line rectifying 50/60 Hz
- Softstart AC motor control
- DC Motor control
- Power converter
- AC power control
- Lighting and temperature control

Package: Y4

- Isolation Voltage: 4800 V~
- Industry standard outline
- RoHS compliant
- Soldering pins for PCB mounting
- Base plate: DCB ceramic
- Reduced weight
- Advanced power cycling

Rectifier			Ratings			
Symbol	Definition	Conditions	min.	typ.	max.	Unit
$V_{RSM/DSM}$	max. non-repetitive reverse/forward blocking voltage	$T_{VJ} = 25^{\circ}\text{C}$			1700	V
$V_{RRM/DRM}$	max. repetitive reverse/forward blocking voltage	$T_{VJ} = 25^{\circ}\text{C}$			1600	V
I_{RD}	reverse current, drain current	$V_{RD} = 1600\text{ V}$	$T_{VJ} = 25^{\circ}\text{C}$		300	μA
		$V_{RD} = 1600\text{ V}$	$T_{VJ} = 140^{\circ}\text{C}$		20	mA
V_T	forward voltage drop	$I_T = 200\text{ A}$	$T_{VJ} = 25^{\circ}\text{C}$		1.12	V
		$I_T = 400\text{ A}$			1.33	V
		$I_T = 200\text{ A}$	$T_{VJ} = 125^{\circ}\text{C}$		1.06	V
		$I_T = 400\text{ A}$			1.31	V
I_{TAV}	average forward current	$T_C = 85^{\circ}\text{C}$	$T_{VJ} = 140^{\circ}\text{C}$		260	A
$I_{T(RMS)}$	RMS forward current	180° sine			408	A
V_{T0}	threshold voltage	} for power loss calculation only	$T_{VJ} = 140^{\circ}\text{C}$		0.81	V
r_T	slope resistance				1.23	m Ω
R_{thJC}	thermal resistance junction to case				0.13	K/W
R_{thCH}	thermal resistance case to heatsink			0.08		K/W
P_{tot}	total power dissipation		$T_C = 25^{\circ}\text{C}$		880	W
I_{TSM}	max. forward surge current	$t = 10\text{ ms}; (50\text{ Hz}), \text{ sine}$	$T_{VJ} = 45^{\circ}\text{C}$		8.30	kA
		$t = 8,3\text{ ms}; (60\text{ Hz}), \text{ sine}$	$V_R = 0\text{ V}$		8.97	kA
		$t = 10\text{ ms}; (50\text{ Hz}), \text{ sine}$	$T_{VJ} = 140^{\circ}\text{C}$		7.06	kA
		$t = 8,3\text{ ms}; (60\text{ Hz}), \text{ sine}$	$V_R = 0\text{ V}$		7.62	kA
I^2t	value for fusing	$t = 10\text{ ms}; (50\text{ Hz}), \text{ sine}$	$T_{VJ} = 45^{\circ}\text{C}$		344.5	kA ² s
		$t = 8,3\text{ ms}; (60\text{ Hz}), \text{ sine}$	$V_R = 0\text{ V}$		334.3	kA ² s
		$t = 10\text{ ms}; (50\text{ Hz}), \text{ sine}$	$T_{VJ} = 140^{\circ}\text{C}$		248.9	kA ² s
		$t = 8,3\text{ ms}; (60\text{ Hz}), \text{ sine}$	$V_R = 0\text{ V}$		241.6	kA ² s
C_J	junction capacitance	$V_R = 400\text{ V}$ $f = 1\text{ MHz}$	$T_{VJ} = 25^{\circ}\text{C}$		366	pF
P_{GM}	max. gate power dissipation	$t_p = 30\text{ }\mu\text{s}$	$T_C = 140^{\circ}\text{C}$		120	W
		$t_p = 500\text{ }\mu\text{s}$			60	W
P_{GAV}	average gate power dissipation				20	W
$(di/dt)_{cr}$	critical rate of rise of current	$T_{VJ} = 140^{\circ}\text{C}; f = 50\text{ Hz}$ repetitive, $I_T = 780\text{ A}$			100	A/ μs
		$t_p = 200\text{ }\mu\text{s}; di_G/dt = 0.5\text{ A}/\mu\text{s};$ $I_G = 0.5\text{ A}; V_D = \frac{2}{3} V_{DRM}$ non-repet., $I_T = 500\text{ A}$			260	A/ μs
$(dv/dt)_{cr}$	critical rate of rise of voltage	$V_D = \frac{2}{3} V_{DRM}$ $R_{GK} = \infty$; method 1 (linear voltage rise)	$T_{VJ} = 140^{\circ}\text{C}$		1000	V/ μs
V_{GT}	gate trigger voltage	$V_D = 6\text{ V}$	$T_{VJ} = 25^{\circ}\text{C}$		2	V
			$T_{VJ} = -40^{\circ}\text{C}$		3	V
I_{GT}	gate trigger current	$V_D = 6\text{ V}$	$T_{VJ} = 25^{\circ}\text{C}$		150	mA
			$T_{VJ} = -40^{\circ}\text{C}$		220	mA
V_{GD}	gate non-trigger voltage	$V_D = \frac{2}{3} V_{DRM}$	$T_{VJ} = 140^{\circ}\text{C}$		0.25	V
I_{GD}	gate non-trigger current				10	mA
I_L	latching current	$t_p = 30\text{ }\mu\text{s}$	$T_{VJ} = 25^{\circ}\text{C}$		200	mA
		$I_G = 0.5\text{ A}; di_G/dt = 0.5\text{ A}/\mu\text{s}$				
I_H	holding current	$V_D = 6\text{ V}$ $R_{GK} = \infty$	$T_{VJ} = 25^{\circ}\text{C}$		150	mA
t_{gd}	gate controlled delay time	$V_D = \frac{1}{2} V_{DRM}$	$T_{VJ} = 25^{\circ}\text{C}$		2	μs
		$I_G = 0.5\text{ A}; di_G/dt = 0.5\text{ A}/\mu\text{s}$				
t_q	turn-off time	$V_R = 100\text{ V}; I_T = 260\text{ A}; V_D = \frac{2}{3} V_{DRM}$ $di/dt = 10\text{ A}/\mu\text{s}; dv/dt = 50\text{ V}/\mu\text{s}; t_p = 200\text{ }\mu\text{s}$	$T_{VJ} = 140^{\circ}\text{C}$		200	μs

Package Y4				Ratings		
Symbol	Definition	Conditions	min.	typ.	max.	Unit
I_{RMS}	RMS current	per terminal			300	A
T_{VJ}	virtual junction temperature		-40		140	°C
T_{op}	operation temperature		-40		125	°C
T_{stg}	storage temperature		-40		125	°C
Weight					150	g
M_D	mounting torque		2.25		2.75	Nm
M_T	terminal torque		4.5		5.5	Nm
$d_{Spp/App}$	creepage distance on surface striking distance through air	terminal to terminal	14.0	10.0		mm
$d_{Spb/Apb}$		terminal to backside	16.0	16.0		mm
V_{ISOL}	isolation voltage	t = 1 second		4800		V
		t = 1 minute	50/60 Hz, RMS; $I_{ISOL} \leq 1$ mA	4000		V

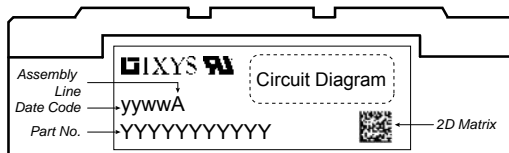
Part number

- M = Module
- C = Thyristor (SCR)
- M = Thyristor
- A = (up to 1800V)
- 260 = Current Rating [A]
- PD = Phase leg
- 1600 = Reverse Voltage [V]
- YB = Y4-M6

Ordering	Part Number	Marking on Product	Delivery Mode	Quantity	Code No.
Standard	MCMA260PD1600YB	MCMA260PD1600YB	Box	6	509778

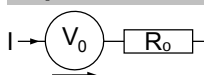
Equivalent Circuits for Simulation
** on die level*
 $T_{VJ} = 140\text{ °C}$

Thyristor

$V_{0\max}$	threshold voltage	0.81	V
$R_{0\max}$	slope resistance *	0.59	mΩ

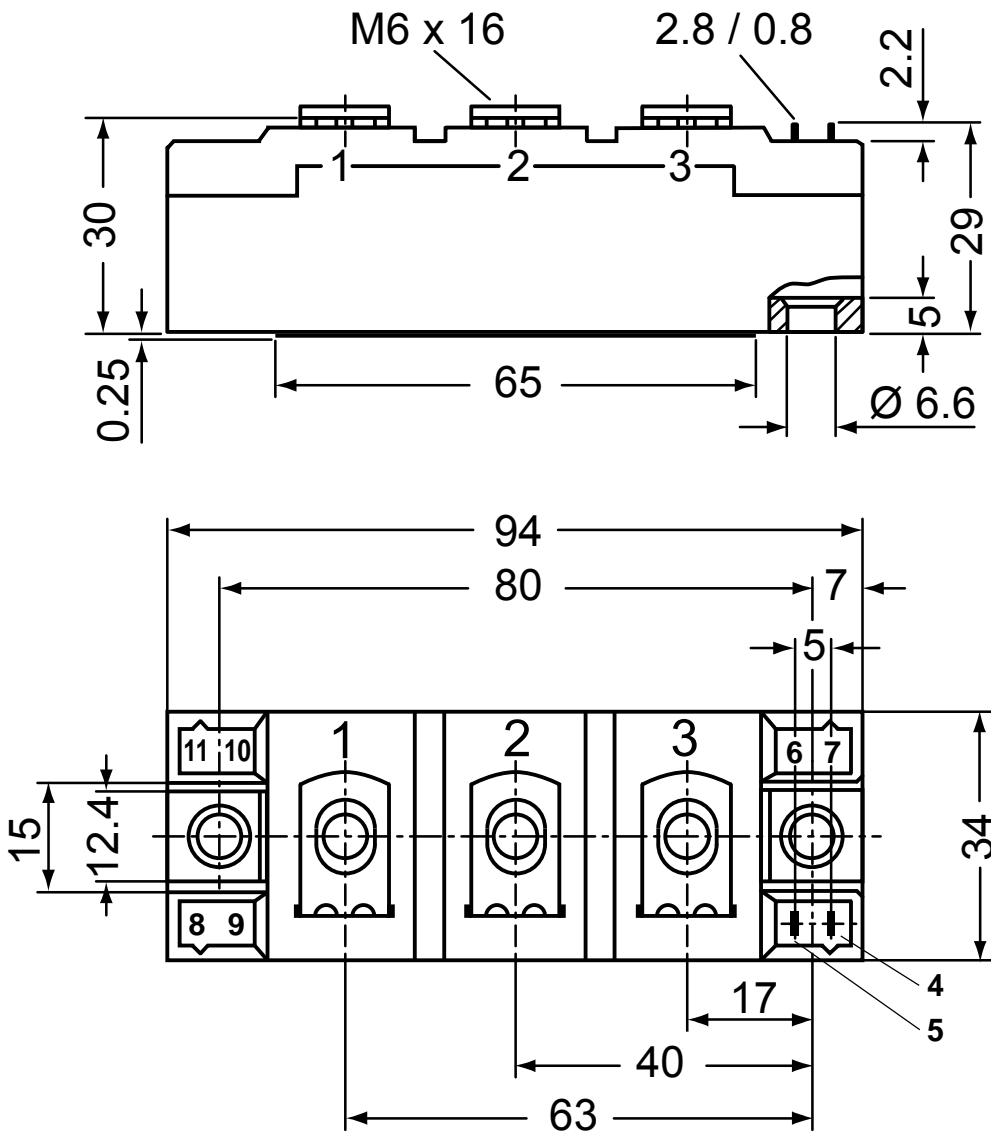
Outlines Y4



Optional accessories for modules

Keyed gate/cathode twin plugs with wire length = 350 mm, gate = white, cathode = red

Type ZY 180L (L = Left for pin pair 4/5) } UL 758, style 3751
 Type ZY 180R (R = Right for pin pair 6/7)

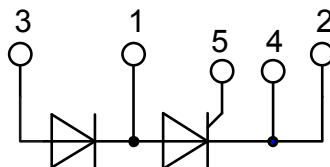

Thyristor

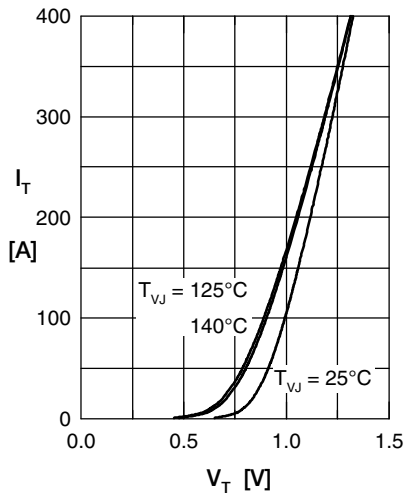

Fig. 1 Forward current vs. voltage drop per thyristor

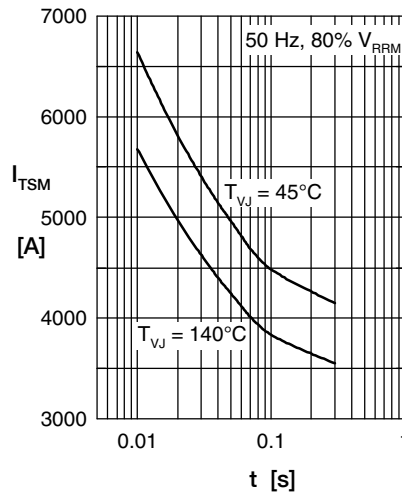

Fig. 2 Surge overload current vs. time per thyristor

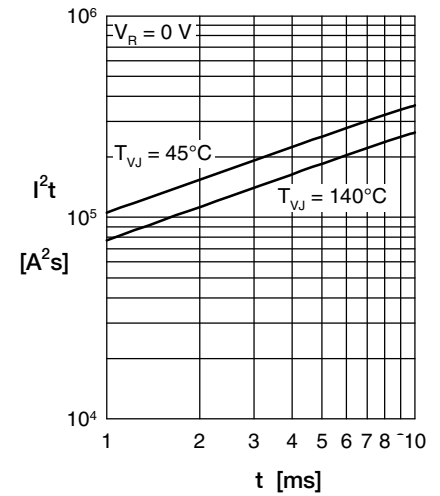

Fig. 3 I^2t vs. time per thyristor

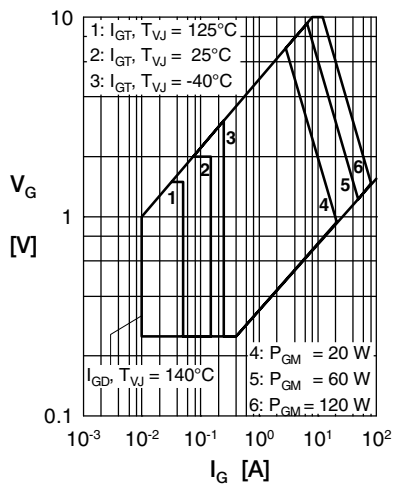

Fig. 4 Gate voltage & gate current

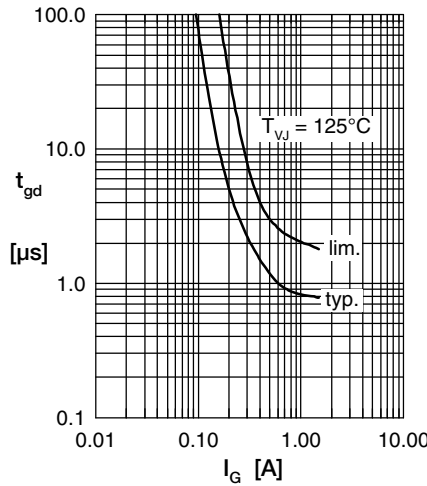

Fig. 5 Gate controlled delay time t_{gd}

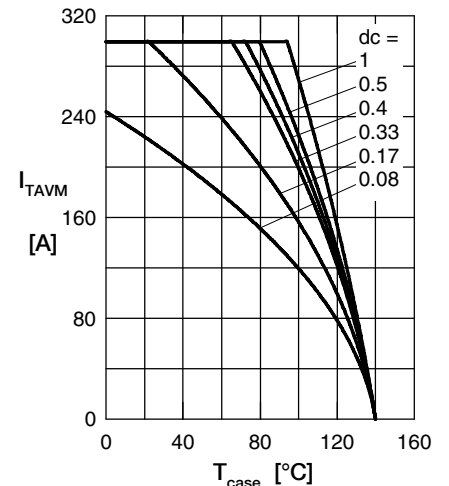

Fig. 6 Max. forward current vs. case temperature per thyristor.

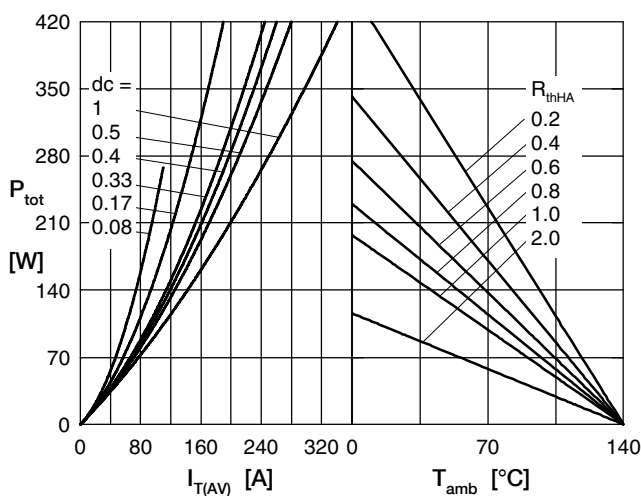

Fig. 7 Power dissipation vs. forward current and ambient temperature per thyristor

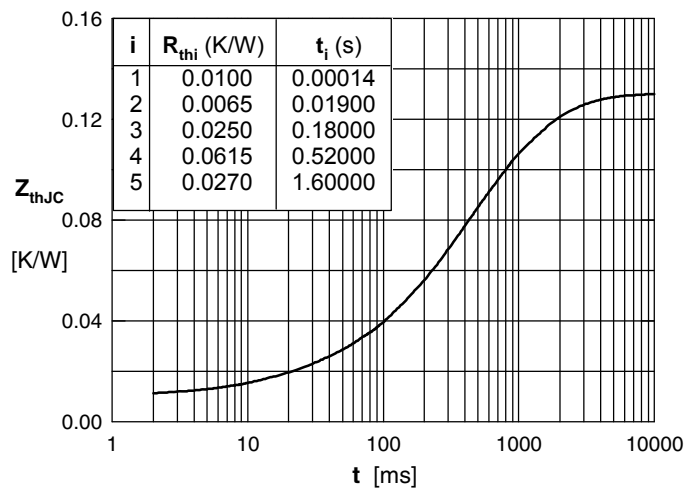

Fig. 8 Transient thermal impedance junction to case vs. time per thyristor