

MCR12DSM, MCR12DSN

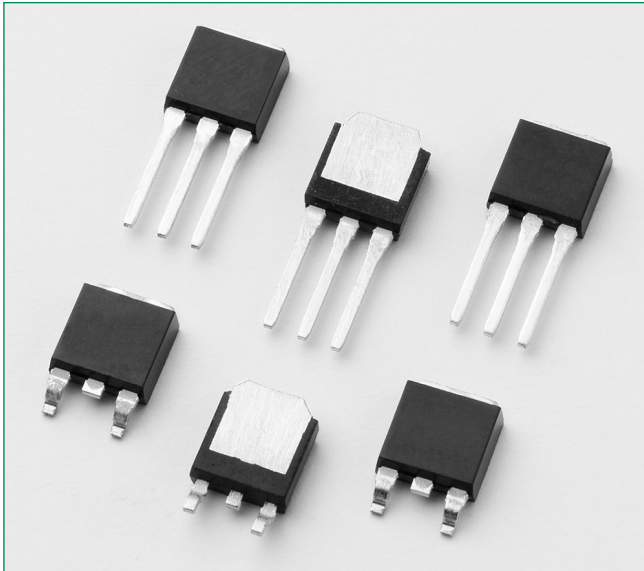

Description

The MCR12DSM and MCR12DSN are designed for high volume, low cost, industrial and consumer applications such as motor control; process control; temperature, light and speed control; CDI (Capacitive Discharge Ignition); and small engines.

Features

- Small Size
- Passivated Die Surface for Reliability and Uniformity
- Low Level Triggering and Holding Characteristics
- UL Recognized compound meeting flammability rating V-0
- ESD Ratings: Human Body Model, 3B > 8000V
Machine Model, C > 400V

Pin Out

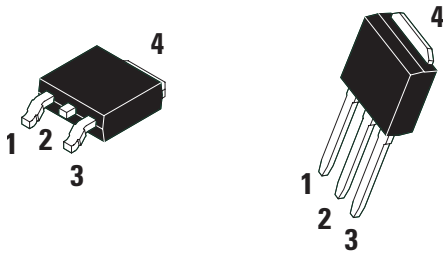

Functional Diagram



Additional Information



Datasheet



Resources



Samples

Maximum Ratings ($T_J = 25^\circ\text{C}$ unless otherwise noted)

Rating	Symbol	Value	Unit
Peak Repetitive Off-State Voltage (Note 1) ($T_C = -40$ to $+110^\circ\text{C}$, Sine Wave, 50 to 60 Hz, $R_{GK} = 1\text{ k}\Omega$)	MCR12DSM MCR12DSN V_{DRM} V_{RRM}	600 800	V
On-State RMS Current (180° Conduction Angles; $T_C = 75^\circ\text{C}$)	$I_{T(RMS)}$	12	A
Average On-State Current (180° Conduction Angles; $T_C = 75^\circ\text{C}$)	$I_{T(AV)}$	7.6	A
Non-Repetitive Surge Current (1/2 Cycle, Sine Wave 60 Hz, $T_J = 110^\circ\text{C}$)	I_{TSM}	100	A
Circuit Fusing Consideration ($t = 8.3\text{ ms}$)	I^2t	41	A^2s
Forward Peak Gate Power (Pulse Width $\leq 1.0\text{ }\mu\text{sec}$, $T_C = 75^\circ\text{C}$)	P_{GM}	5.0	W
Forward Average Gate Power ($t = 8.3\text{ ms}$, $T_C = 75^\circ\text{C}$)	$P_{G(AV)}$	0.5	W
Forward Peak Gate Current (Pulse Width $\leq 1.0\text{ }\mu\text{sec}$, $T_C = 75^\circ\text{C}$)	I_{GM}	2.0	A
Operating Junction Temperature Range	T_J	-40 to +110	$^\circ\text{C}$
Storage Temperature Range	T_{STG}	-40 to +150	$^\circ\text{C}$

Stresses exceeding Maximum Ratings may damage the component. Maximum Ratings are stress ratings only. Functional operation above the Recommended Operating Conditions is not implied. Extended exposure to stresses above the Recommended Operating Conditions may affect component reliability.
 1. V_{DRM} and V_{RRM} for all types can be applied on a continuous basis. Ratings apply for zero or negative gate voltage; however, positive gate voltage shall not be applied concurrent with negative potential on the anode. Blocking voltages shall not be tested with a constant current source such that the voltage ratings of the component are exceeded.

Thermal Characteristics

Rating	Symbol	Value	Unit
Thermal Resistance, Junction-to-Case	$R_{\theta JC}$	2.2	$^\circ\text{C/W}$
Thermal Resistance, Junction-to-Ambient	$R_{\theta JA}$	88	
Thermal Resistance, Junction-to-Ambient (Note 2)	$R_{\theta JA}$	80	
Maximum Lead Temperature for Soldering Purposes (Note 3)	T_L	260	$^\circ\text{C}$

Electrical Characteristics - OFF ($T_J = 25^\circ\text{C}$ unless otherwise noted)

Characteristic	Symbol	Min	Typ	Max	Unit	
Peak Repetitive Forward or Reverse Blocking Current ($V_{AK} = \text{Rated } V_{DRM} \text{ or } V_{RRM}$, $R_{GK} = 1.0\text{ k}\Omega$) ⁴	I_{DRM} I_{RRM}	$T_J = 25^\circ\text{C}$	-	-	10	μA
		$T_J = 110^\circ\text{C}$	-	-	500	

Electrical Characteristics - ON ($T_J = 25^\circ\text{C}$ unless otherwise noted)

Characteristic	Symbol	Min	Typ	Max	Unit	
Peak Reverse Gate Blocking Voltage, ($I_{GR} = 10\text{ }\mu\text{A}$)	V_{GRM}	10	12.5	18	V	
Peak Reverse Gate Blocking Current, ($V_{GR} = 10\text{ V}$)	I_{GRM}	-	-	1.2	μA	
Peak Forward On-State Voltage (Note 5), ($I_{TM} = 20\text{ A}$)	V_{TM}	-	1.3	1.9	V	
Gate Trigger Voltage (Note 6) ($V_{AK} = 12\text{ Vdc}$; $R_L = 100\text{ }\Omega$, $T_C = 110^\circ$)	I_{GT}	$T_J = 25^\circ\text{C}$	5.0	12	200	μA
		$T_J = -40^\circ\text{C}$	-	-	300	
Gate Trigger Voltage (Continuous dc) (Note 6) ($V_{AK} = 12\text{ V}$; $R_L = 100\text{ }\Omega$)	V_{GT}	$T_J = 25^\circ\text{C}$	0.45	0.65	1.0	V
		$T_J = -40^\circ\text{C}$	-	-	1.5	
		$T_J = 110^\circ\text{C}$	0.2	-	-	
Holding Current ($V_D = 12\text{ V}$, Initiating Current = 200 mA, $R_{GK} = 1\text{ k}\Omega$)	I_H	$T_J = 25^\circ\text{C}$	0.5	1.0	6.0	mA
		$T_J = -40^\circ\text{C}$	-	-	10	
Latching Current ($V_D = 12\text{ V}$, $I_G = 2.0\text{ mA}$, $R_{GK} = 1\text{ k}\Omega$)	I_L	$T_J = 25^\circ\text{C}$	0.5	1.0	6.0	mA
		$T_J = -40^\circ\text{C}$	-	-	10	
Peak Reverse Gate Blocking Current ($V_{GR} = 10\text{ V}$)	I_{RGM}	-	-	1.2	μA	
Turn-On Time (Source Voltage = 12 V, $R_S = 6.0\text{ k}\Omega$, $I_T = 16\text{ A(pk)}$, $R_{GK} = 1.0\text{ k}\Omega$) ($V_D = \text{Rated } V_{DRM}$, Rise Time = 20 ns, Pulse Width = 10 μs)	t_{gt}	-	2.0	5.0	μs	

Dynamic Characteristics

Characteristic	Symbol	Min	Typ	Max	Unit
Critical Rate of Rise of Off-State Voltage ($V_D = 0.67 \times \text{Rated VDRM}$, Exponential Waveform, 100 ohm, $T_j = 110^\circ\text{C}$)	dv/dt	37	45	-	V/ μs
Critical Rate of Rise of On-State Current ($I_{PK} = 50 \text{ A}$, $PW = 40 \text{ sec}$, $di/dt = 1 \text{ A/sec}$, $IGT = 10 \text{ mA}$)	di/dt	-	50	100	A/ μs

- 2. These ratings are applicable when surface mounted on the minimum pad sizes recommended.
- 3. 1/8" from case for 10 seconds.
- 4. Ratings apply for negative gate voltage or $R_{gk} = 1.0 \text{ k}\Omega$. Devices shall not have a positive gate voltage concurrently with a negative voltage on the anode. Component should not be tested with a constant current source for forward and reverse blocking capability such that the voltage applied exceeds the rated blocking voltage.
- 5. Pulse Test: Pulse Width $\leq 2.0 \text{ msec}$, Duty Cycle $\leq 2\%$.
- 6. R_{gk} current not included in measurement.

Voltage Current Characteristic of SCR

Symbol	Parameter
V_{DRM}	Peak Repetitive Forward Off State Voltage
I_{DRM}	Peak Forward Blocking Current
V_{RRM}	Peak Repetitive Reverse Off State Voltage
I_{RRM}	Peak Reverse Blocking Current
V_{TM}	Maximum On State Voltage
I_H	Holding Current

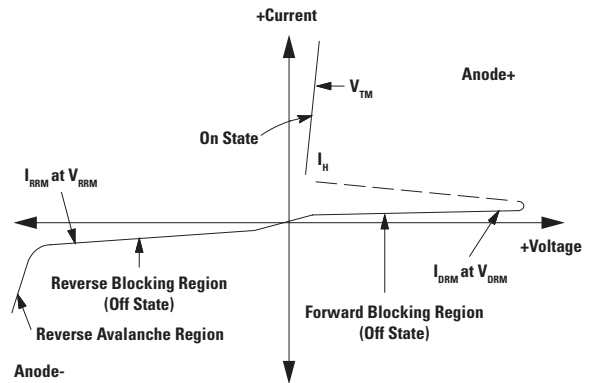

Figure 1. Average Current Derating

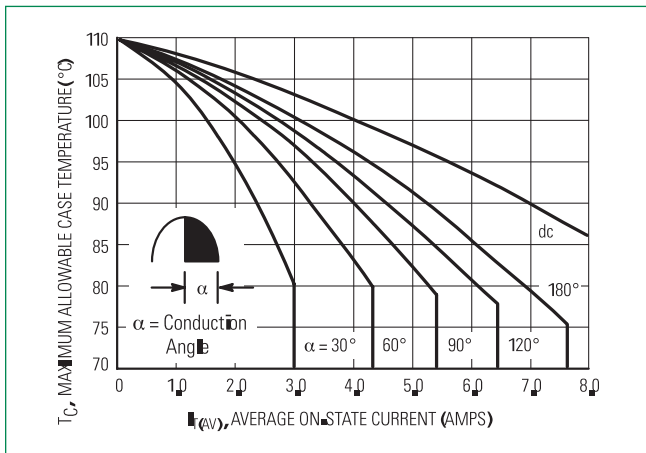

Figure 2. On-State Power Dissipation

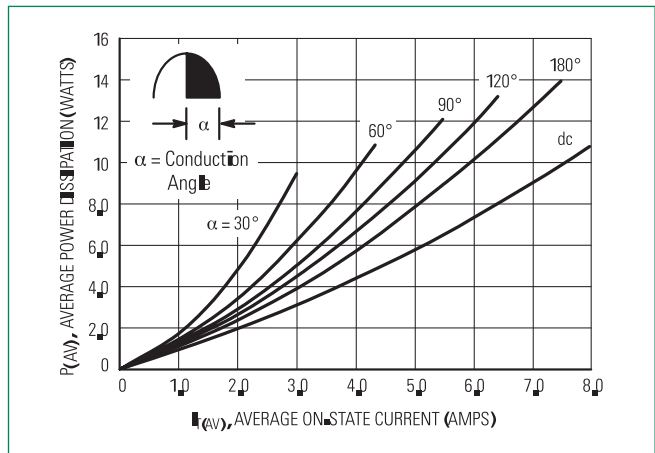

Figure 3. On-State Characteristics

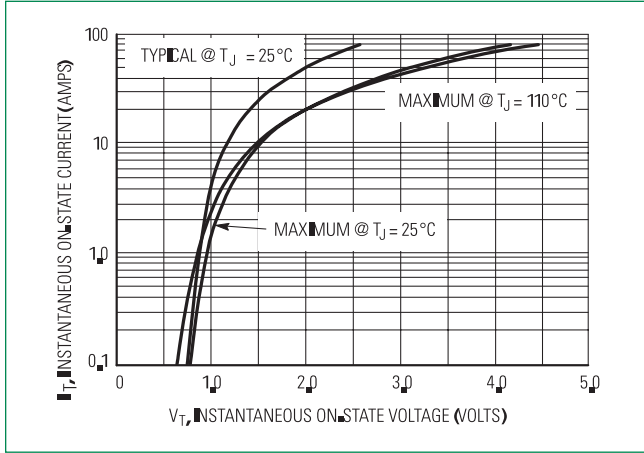

Figure 4. Transient Thermal Response

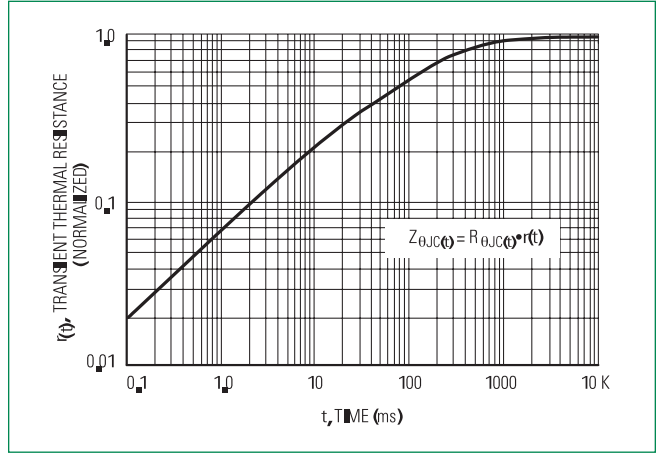

Figure 5. Typical Gate Trigger Current vs. Junction Temperature

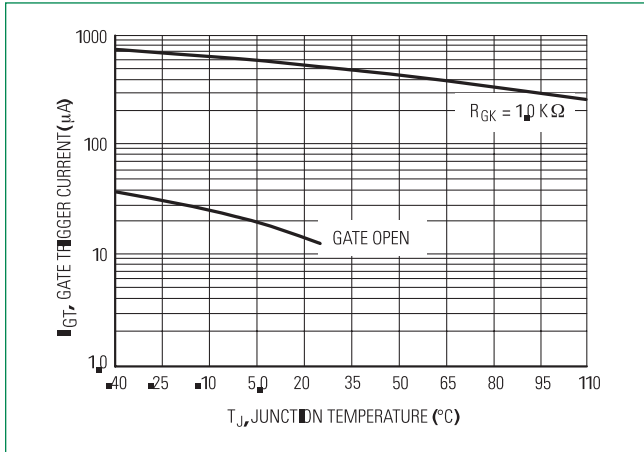

Figure 6. Typical Gate Trigger Voltage vs. Junction Temperature

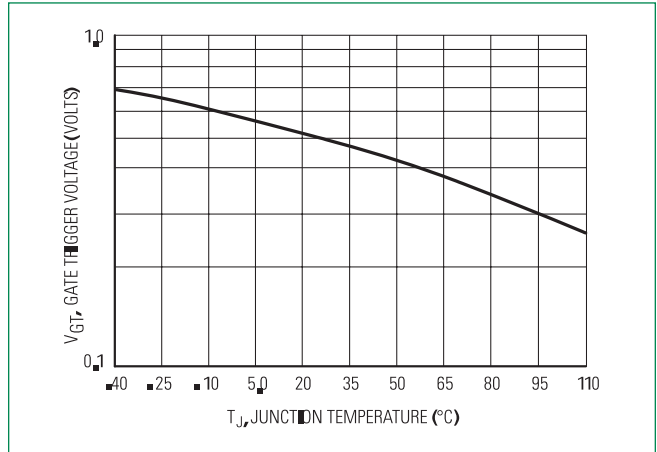

Figure 7. Typical Holding Current vs. Junction Temperature

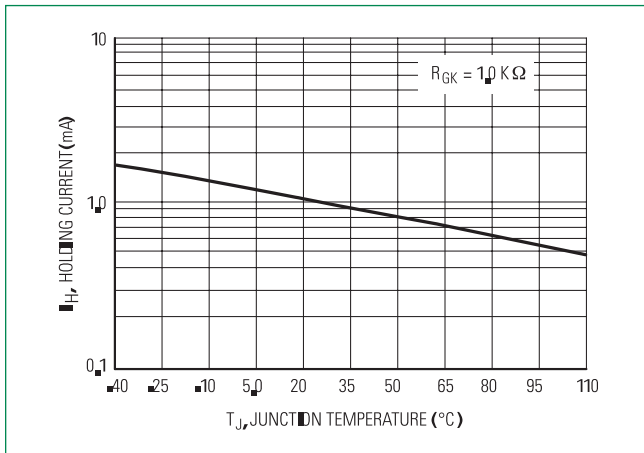

Figure 8. Typical Latching Current vs. Junction Temperature

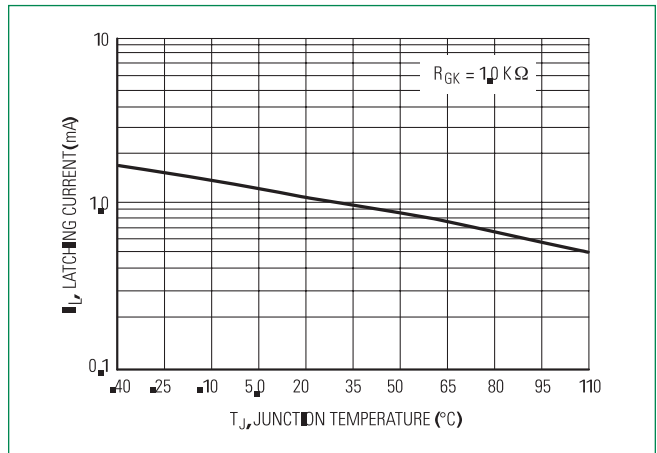

Figure 9. Holding Current vs Gate-Cathode Resistance

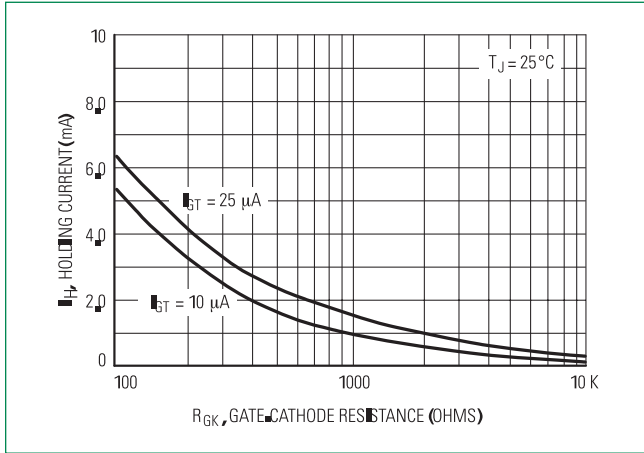

Fig. 10 Exponential Static dv/dt vs Gate-Cathode Resistance & Junction Temp

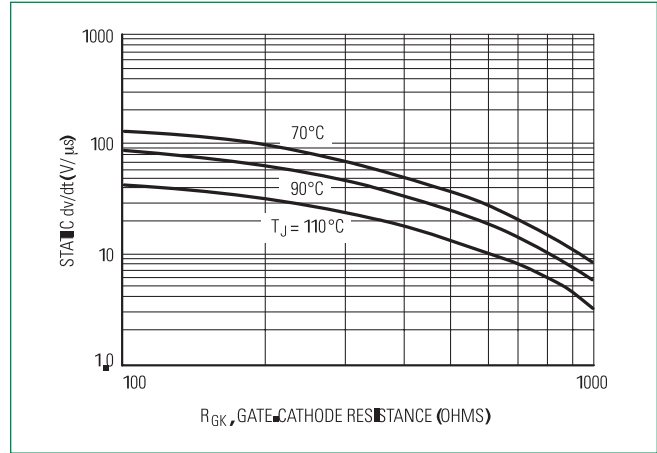

Figure 11. Typical Gate Trigger Current vs Junction Temperature

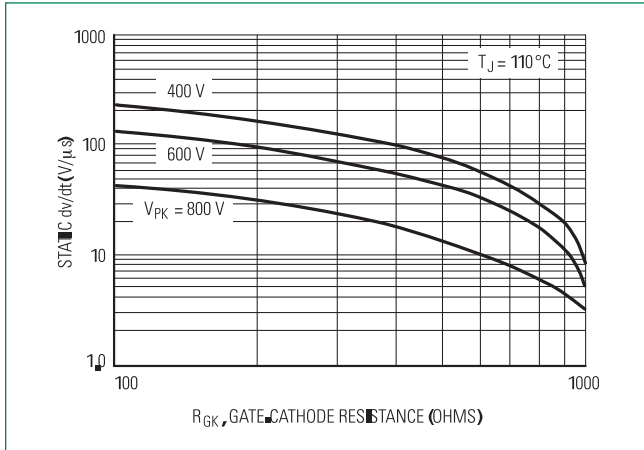
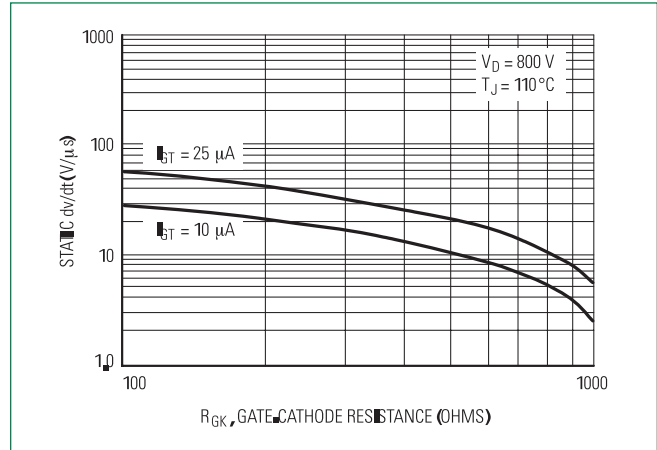
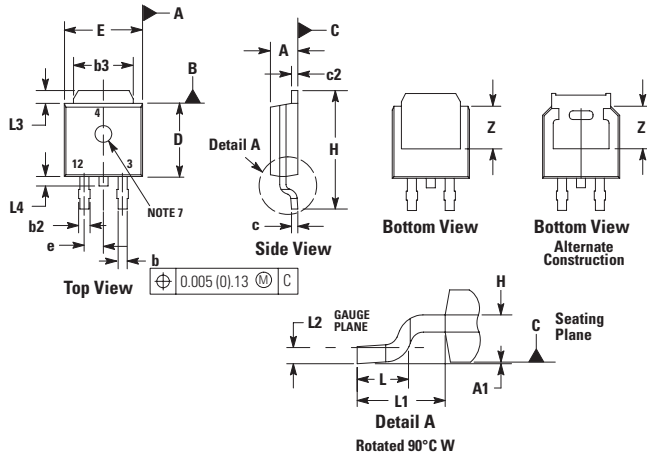

Figure 12. Typical Gate Trigger Voltage vs Junction Temperature



Dimensions



Soldering Footprint

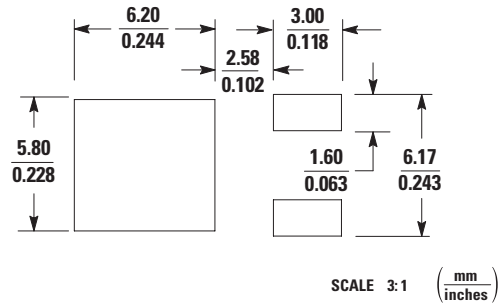

Dim	Inches		Millimeters	
	Min	Max	Min	Max
A	0.087	0.094	2.20	2.40
A1	0.000	0.005	0.00	0.12
b	0.022	0.030	0.55	0.75
b2	0.026	0.033	0.65	0.85
b3	0.209	0.217	5.30	5.50
c	0.019	0.023	0.49	0.59
c2	0.019	0.023	0.49	0.59
D	0.213	0.224	5.40	5.70
E	0.252	0.260	6.40	6.60
e	0.091		2.30	
H	0.374	0.406	9.50	10.30
L	0.058	0.070	1.47	1.78
L1	0.114		2.90	
L2	0.019	0.023	0.49	0.59
L3	0.053	0.065	1.35	1.65
L4	0.028	0.039	0.70	1.00
Z	0.154	-	3.90	-

1. Dimensioning and tolerancing per asme y14.5m, 1994.
2. Controlling dimension: inch.
3. Thermal pad contour optional within di- mensions b3, l3 and z.
4. Dimensions d and e do not include mold flash, protrusions, or burrs. Mold flash, protrusions, or gate burrs shall l3 z not exceed 0.006 inches per side.
5. Dimensions d and e are determined at the outermost extremes of the plastic body.
6. Datums a and b are determined at datum plane h.

Dimensions

DPAK-3
Case 369D
T0251-3L POD

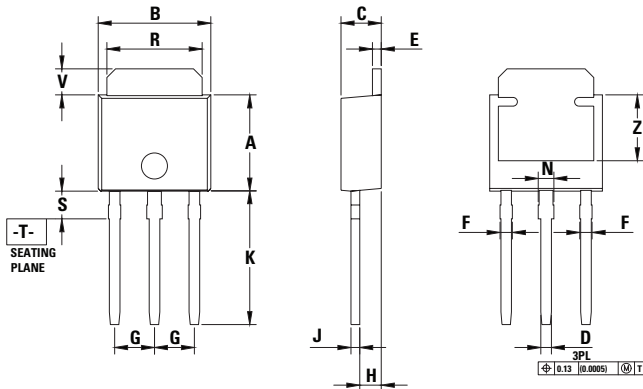

Dim	Inches		Millimeters	
	Min	Max	Min	Max
A	0.213	0.224	5.40	5.70
B	0.252	0.260	6.40	6.60
C	0.087	0.094	2.20	2.40
D	0.024	0.030	0.60	0.75
E	0.022	0.026	0.55	0.65
F	0.022	0.03	0.58	0.78
G	0.091		2.30	
H	0.046	0.050	1.18	1.28
J	0.019	0.023	0.49	0.59
K	0.291	0.315	7.40	8.00
N	0.031	0.038	0.78	0.98
R	0.209	0.217	5.30	5.50
S	0.063		1.60	
V	0.053	0.065	1.35	1.65
Z	0.150		3.80	

1. Dimensioning and Tolerancing Per ANSI Y14.5M, 1982.
2. Controlling Dimension: Inch.
STYLE 6: Pin 1. MT1
2. MT2
3. Gate
4. MT2

Part Marking System

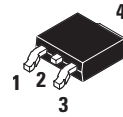

DPAK-3
Case 369C
Style 4

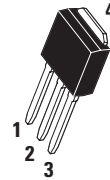
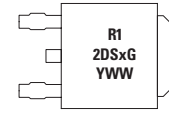

DPAK-3
Case 369D
Style 4

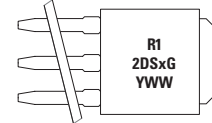

R12DSx = Device Code
x = M, or N
Y = Year
WW = Work Week
G = Pb-Free Package

Pin Assignment

1	Cathode
2	Anode
3	Gate
4	Anode

Ordering Information

Device	Package Type	Package	Shipping
MCR12DSMT4G	DPAK	369C	2500 Tape & Reel
MCR12DSN-1G	IPAK	369D	4000 Units/Box
MCR12DSNT4G	DPAK	369C	2500 Tape & Reel