



Material/Product Safety Data Sheet (MSDS-PSDS)

LS/LSH Products	Lithium/Thionyl chloride single cells and multi-cell battery packs
Revision 10 Date 02/2011	

1. Identification of the Substance or Preparation and Company

Product	Primary Lithium/Thionyl chloride unit cells and multi-cell battery packs (Li-SOCl₂)			
Production sites	Saft Ltd. River Drive Tyne & Wear South Shields NE33 2TR – UK Ph. :+44 191 456 1451 Fax :+44 191 456 6383	Saft Rue Georges Leclanché BP 1039 86060 Poitiers cedex 9 France Ph. :+33 (0)5 49 55 48 48 Fax :+33 (0)5 49 55 48 50	Saft America Inc 313 Crescent Street Valdese NC 28690 – USA Ph. :+1 828 874 4111 Fax :+1 828 874 2431	Saft Batteries Co., Ltd Zhuhai Free Trade Zone Lianfeng Road Zhuhai 519030 Guangdong Province China Ph. : +86 756 881 9318 Fax : +86 756 881 9328

www.saftbatteries.com (section "Contact")

Emergency contact
 For chemical emergency ONLY (spill, leak, fire, exposure or accident),
 call CHEMTREC at:
 International: +1-703-527-3887
 Within the USA: 1-800-424-9300



2. Hazards Identification

Do not short circuit, recharge, puncture, incinerate, crush, immerse, force discharge or expose to temperatures above the declared operating temperature range of the product. Risk of fire or explosion. The Lithium-Thionyl chloride batteries described in this Safety Data Sheet are sealed units which are not hazardous when used according to the recommendations of the manufacturer.

Under normal conditions of use, the electrode materials and liquid electrolyte they contain are not exposed to the outside, provided the battery integrity is maintained and seals remain intact. Risk of exposure only in case of abuse (mechanical, thermal, electrical) which leads to the activation of safety valves and/or the rupture of the battery container. Electrolyte leakage, electrode materials reaction with moisture/water or battery vent/explosion/fire may follow, depending upon the circumstances.

3. Composition & Information on Ingredients

Each cell consists of a hermetically sealed metallic container containing a number of chemicals and materials of construction of which the following could potentially be hazardous upon release.

Ingredient	Content	CAS No.	CHIP Classification		
Lithium (Li)	3.5-5%	7439-93-2			F ; R14/15 C ; R34 R14/15, R21,R22, R35, R41, R43 S2, S8, S45



Thionyl chloride (SOCl ₂)	40-46%	7719-09-7			C; R14, R21, R22, R35, R37, R41, R42/43 S2, S8, S24, S26, S36, S37, S45
Aluminum chloride anhydrous (AlCl ₃)	1-5%	7446-70-0			R14, R22, R37, R41, R43. S2, S8, S22, S24, S26, S36, S45
Carbon (C _n)	3-4%	1333-86-4			NONE KNOWN
<i>Amount varies depending on cell size.</i>					





4. First Aid Measures	
Inhalation	Remove from exposure, rest and keep warm. In severe cases obtain medical attention.
Skin contact	Wash off skin thoroughly with water. Remove contaminated clothing and wash before re-use. In severe cases obtain medical attention.
Eye contact	Irrigate thoroughly with water for at least 15 minutes. Obtain medical attention.
Ingestion	Wash out mouth thoroughly with water and give plenty of water to drink. Obtain medical attention.
Further treatment	All cases of eye contamination, persistent skin irritation and casualties who have swallowed this substance or been affected by breathing its vapours should be seen by a Doctor.

5. Fire Fighting Measures	
<p>CO₂ extinguishers or, even preferably, copious quantities of water or water-based foam, can be used to cool down burning Li- SOCl₂ cells and batteries, as long as the extent of the fire has not progressed to the point that the lithium metal they contain is exposed (marked by deep red flames). Do not use for this purpose sand, dry powder or soda ash, graphite powder or fire blankets. Use only metal (Class D) extinguishers on raw lithium.</p>	
Extinguishing media	Use water or CO ₂ on burning Li-SOCl ₂ cells or batteries and class D fire extinguishing agent only on raw lithium.

6. Accidental Release Measures	
<p>Remove personnel from area until fumes dissipate. Do not breathe vapours or touch liquid with bare hands. If the skin has come into contact with the electrolyte, it should be washed thoroughly with water. Sand or earth should be used to absorb any exuded material. Seal leaking battery and contaminated absorbent material in plastic bag and dispose of as Special Waste in accordance with local regulations.</p>	



7. Handling and Storage	
Handling	Do not crush, pierce, short (+) and (-) battery terminals with conductive (i.e. metal) goods. Do not directly heat or solder. Do not throw into fire. Do not mix batteries of different types and brands. Do not mix new and used batteries. Keep batteries in non conductive (i.e. plastic) trays.
Storage	Store in a cool (preferably below 30°C) and ventilated area, away from moisture, sources of heat, open flames, food and drink. Keep adequate clearance between walls and batteries. Temperature above 100°C may result in battery leakage and rupture. Since short circuit can cause burns, leakage and rupture hazard, keep batteries in original packaging until use and do not jumble them.
Other	Lithium-Thionyl chloride batteries are not rechargeable and should not be tentatively charged. Follow Manufacturers recommendations regarding maximum recommended currents and operating temperature range. Applying pressure on deforming the battery may lead to disassembly followed by eye, skin and throat irritation.

8. Exposure Controls & Personal Protection				
Occupational exposure standard	Compound	8hr TWA	15min TWA	SK
	Sulfur dioxide	1 ppm	1 ppm	-
	Hydrogen chloride	1 ppm	5 ppm	-
	Respiratory protection	In all fire situations, use self-contained breathing apparatus.		
	Hand protection	In the event of leakage wear gloves.		
	Eye protection	Safety glasses are recommended during handling.		
	Other	In the event of leakage, wear chemical apron.		

9. Physical and Chemical Properties	
Appearance	Cylindrical or prismatic shape
Odour	If leaking, gives off a pungent corrosive odour.
pH	Not applicable
Flash point	Not applicable unless individual components exposed
Flammability	Not applicable unless individual components exposed
Relative density	Not applicable unless individual components exposed
Solubility (water)	Not applicable unless individual components exposed
Solubility (other)	Not applicable unless individual components exposed



10. Stability and Reactivity	
Product is stable under conditions described in Section 7.	
Conditions to avoid.	Heat above 100 (150°C for the LSH 20-150 cells and the battery packs assembled from them) or incinerate. Deform. Mutilate. Crush. Pierce. Disassemble Recharge. Short circuit. Expose over a long period to humid conditions.
Materials to avoid	Oxidising agents, alkalis, water. Avoid electrolyte contact with aluminum or zinc.
Hazardous decomposition Products	Hydrogen (H ₂) as well as Lithium oxide (Li ₂ O) and Lithium hydroxide (LiOH) dust is produced in case of reaction of <i>lithium metal</i> with water. Chlorine (Cl ₂), Sulfur dioxide (SO ₂) and Disulfur dichloride (S ₂ Cl ₂) are produced in case of thermal decomposition of <i>Thionyl chloride</i> above 140°C. Hydrochloric acid (HCl) and Sulfur dioxide (SO ₂) are produced in case of reaction of <i>Thionyl chloride</i> with water at room temperature. Hydrochloric acid (HCl) fumes, Lithium oxide, (Li ₂ O), Lithium hydroxide (LiOH) and Aluminum hydroxide (Al(OH) ₃) dust are produced in case of reaction of <i>Lithium tetrachloroaluminate (LiAlCl₄)</i> with water.

11. Toxicological Information	
Signs & symptoms	None, unless battery ruptures. In the event of exposure to internal contents, corrosive fumes will be very irritating to skin, eyes and mucous membranes. Overexposure can cause symptoms of non-fibrotic lung injury and membrane irritation.
Inhalation	Lung irritant.
Skin contact	Skin irritant
Eye contact	Eye irritant.
Ingestion	Tissue damage to throat and gastro-respiratory tract if swallowed.
Medical conditions generally aggravated by exposure	In the event of exposure to internal contents, eczema, skin allergies, lung injuries, asthma and other respiratory disorders may occur.

12. Ecological Information	
Mammalian effects	None known if used/disposed of correctly.
Eco-toxicity	None known if used/disposed of correctly.
Bioaccumulation potential	None known if used/disposed of correctly.
Environmental fate	None known if used/disposed of correctly.

13. Disposal Considerations	
Do not incinerate, or subject cells to temperatures in excess of 100°C. Such abuse can result in loss of seal, leakage, and/or cell explosion. Dispose of in accordance with appropriate local regulations.	



14. Transport Information

Note : when manufacturing a new battery pack, one must assure that it is tested in accordance with the UN Model Regulations, Manual of Tests and Criteria, Part III, subsection 38.3

Label for conveyance	For the single cell batteries and multicell battery packs that are non-restricted to transport (non-assigned to the Miscellaneous Class 9), use lithium batteries inside label. For the single cell batteries and multicell battery packs which are restricted to transport (assigned to Class 9), use Class 9 Miscellaneous Dangerous Goods and UN Identification Number labels. In all cases, refer to the product transport certificate issued by the Manufacturer.
UN numbers	UN 3090 (shipment of cells and batteries <i>in bulk</i>) UN 3091 (cells and batteries <i>contained in equipment or packed with it</i>)
Shipping names	Lithium Metal Batteries
Hazard classification	Depending on their lithium metal content, some single cells and small multicell battery packs may be non-assigned to Class 9 (Refer to Transport Certificate)
Packing Group	II
IMDG Code	3090 (Li batteries) 3091 (Li batteries contained in equipment or packed with it)
CAS	
EmS No.	F-A , S-I
Marine pollutant	No
ADR Class	Class 9

15. Regulatory Information

Regulations specifically applicable to the product:

- ACGIH and OSHA: see exposure limits of the internal ingredients of the battery in section 8.
- IATA/ICAO (air transportation): UN 3090 or UN 3091
- IMDG (sea transportation) : UN 3090 or UN 3091
- Transportation within the US-DOT, 49 Code of Federal Regulations

Risk phrases	Lithium (Li)	R14/15 R21 R22 R35 R41 R42/43	Reacts violently with water, liberating extremely flammable gases. Harmful in contact with skin. Harmful if swallowed. Causes burns. Risk of serious damage to eye. May cause sensitization by inhalation and skin contact.
	Thionyl chloride (SOCl ₂)	R14 R22 R35 R37 R41 R42/43	Reacts with water. Harmful if swallowed. Causes burns. Irritating to respiratory system. Risk of serious damage to eye. May cause sensitization by inhalation and skin contact.
	Aluminum chloride anhydrous (AlCl ₃)	R14 R22 R37 R41 R43	Reacts with water. Harmful if swallowed. Irritating to respiratory system. Risk of serious damage to eye. May cause sensitization by skin contact.



Safety phrases	Lithium (Li)	S2 S8 S45	Keep out of reach of children Keep away from moisture In case of incident, seek medical attention.
	Thionyl chloride (SOCl ₂)	S2 S8 S24 S26 S36 S37 S45	Keep out of reach of children. Keep away from moisture. Avoid contact with skin. In case of contact with eyes, rinse immediately with plenty of water. Wear suitable protective clothing. Wear suitable gloves. In case of incident, seek medical attention.
	Aluminum chloride anhydrous (AlCl ₃)	S2 S8 S22 S24 S26 S36	Keep out of reach of children. Keep away from moisture. Do not breathe dust. Avoid contact with skin. In case of contact with eyes, rinse immediately with plenty of water. Wear suitable protective clothing.
UK regulatory references	Classified under CHIP		

16. Other Information
<p>This information has been compiled from sources considered to be dependable and is, to the best of our knowledge and belief, accurate and reliable as of the date compiled. However, no representation, warranty (either expressed or implied) or guarantee is made to the accuracy, reliability or completeness of the information contained herein.</p> <p>This information relates to the specific materials designated and may not be valid for such material used in combination with any other materials or in any process. It is the user's responsibility to satisfy himself as to the suitability and completeness of this information for his particular use.</p> <p>Saft does not accept liability for any loss or damage that may occur, whether direct, indirect, incidental or consequential, from the use of this information. Saft does not offer warranty against patent infringement.</p>

Edition 10 – February 2011

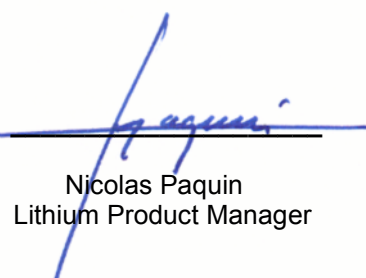
Signature 

Nicolas Paquin
Lithium Product Manager

Primary lithium battery

LS 14250

3.6 V Primary lithium-thionyl chloride (Li-SOCl₂)
 High energy density
 1/2 AA-size bobbin cell



Benefits

- High voltage response, stable during most of the lifetime of the application
- Wide operating temperature range (-60°C/+85°C)
- Low self-discharge rate (less than 1 % per year of storage at +20°C)
- Easy integration into compact systems
- Superior resistance to atmospheric corrosion

Key features

- Stainless steel container and end caps (low magnetic signature)
- Hermetic glass-to-metal sealing
- Non-flammable electrolyte
- Compliant with IEC 60086-4 safety standard and IEC 60079-11 intrinsic safety standard (class T4 assignment)
- Underwriters Laboratories (UL) Component Recognition
- Non-restricted for transport/ Non-assigned to Class 9 according to the UN Recommendations on the transport of dangerous goods – Model Regulations
- Manufactured in France, UK, China

Main applications

- Utility metering
- Automatic meter reading
- Alarms and security devices
- Tollgate systems
- Memory back-up
- Computer real-time clocks
- Tracking systems
- Automotive electronics
- Professional electronics

Cell size references

1/2 R6 – 1/2 AA

Electrical characteristics

(typical values relative to cells stored for one year or less at +30°C max.)

Nominal capacity (at 1 mA +20°C 2.0 V cut-off. The capacity restored by the cell varies according to current drain, temperature and cut-off)	1.20 Ah
Open circuit voltage (at +20°C)	3.67 V
Nominal voltage (at 0.1 mA +20°C)	3.6 V
Nominal energy	4.32 Wh

Pulse capability: Typically up to 100 mA
 (100 mA/0.1 second pulses, drained every 2 mn at +20°C from undischarged cells with 10 µA base current, yield voltage readings above 3.0 V. The readings may vary according to the pulse characteristics, the temperature, and the cell's previous history. Fitting the cell with a capacitor may be recommended in severe conditions. Consult Saft)

Maximum recommended continuous current (Higher currents are possible, consult Saft)	35 mA
Storage (recommended) (for more severe conditions, consult Saft)	+30°C (+86°F) max
Operating temperature range (Operation above ambient T may lead to reduced capacity and lower voltage readings at the beginning of pulses. Consult Saft)	-60°C/+85°C (-76°F/+185°F)

Physical characteristics

Diameter (max)	14.55 mm (0.57 in)
Height (max)	25.15 mm (0.99 in)
Typical weight	8.9 g (0.3 oz)
Li metal content	approx. 0.3 g

Available termination suffix

CN, CNR	radial tabs
2 PF, 3 PF, 3 PF RP, 4 PF	radial pins
CNA (AX)	axial leads
FL	flying leads...etc.



LS 14250

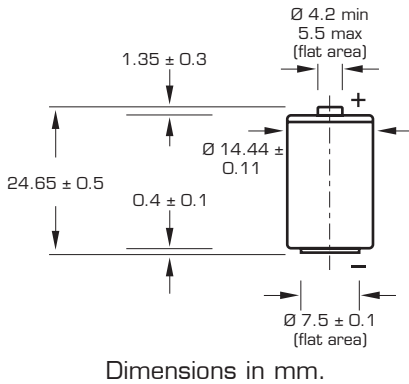

Voltage plateau versus Current and Temperature (at mid-discharge)

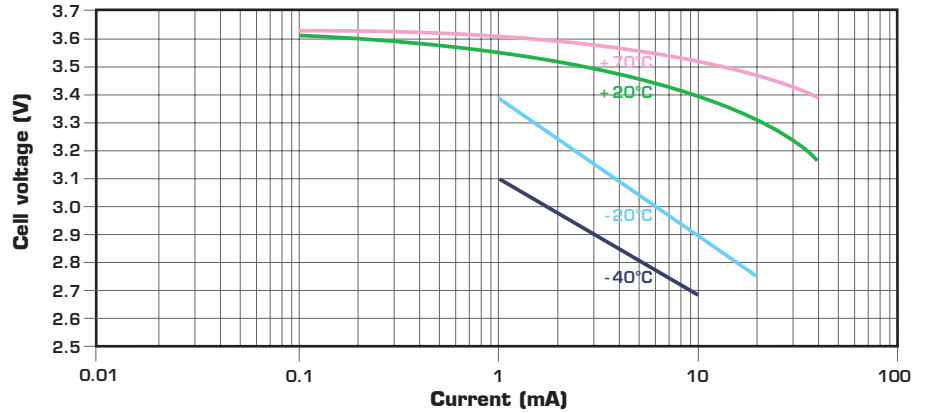

Typical discharge profiles at +20°C

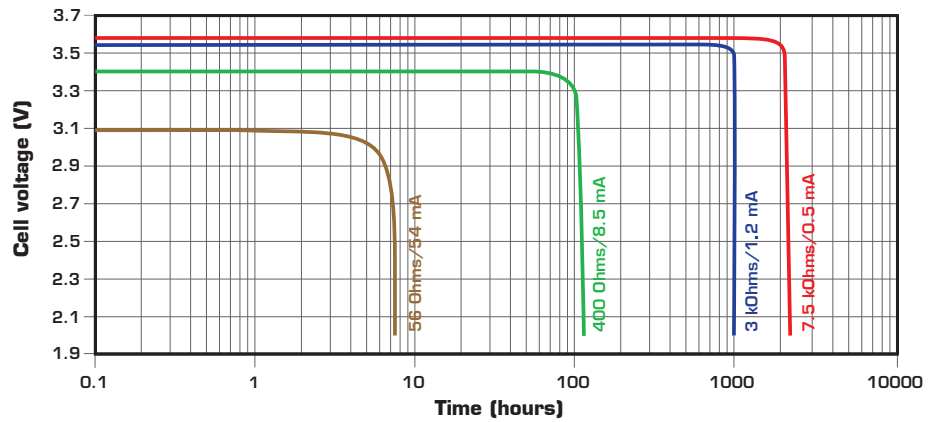

Storage

- The storage area should be clean, cool (preferably not exceeding +30°C), dry and ventilated.

Warning

- Fire, explosion and burn hazard.
- Do not recharge, short circuit, crush, disassemble, heat above 100°C (212°F), incinerate, or expose contents to water.
- Do not solder directly to the cell (use tabbed cell versions instead).

Restored Capacity versus Current and Temperature (2.0 V cut-off)

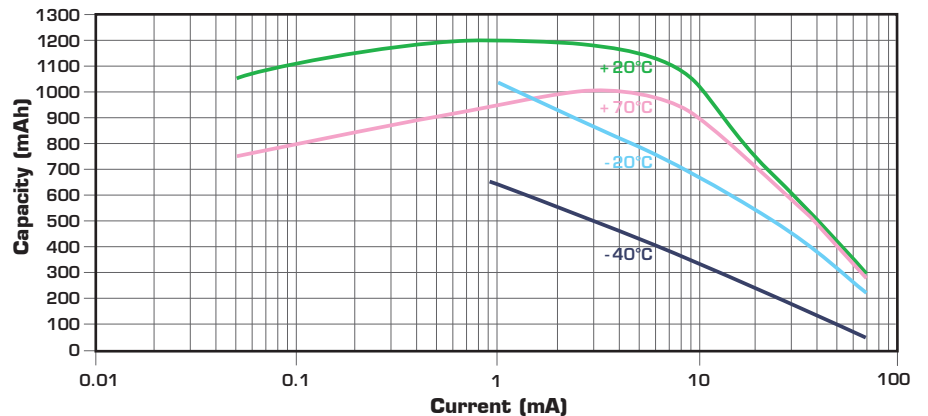

Saft

Specialty Battery Group

12, rue Sadi Carnot
93170 Bagnolet - France
Tel.: +33 (0)1 49 93 19 18
Fax: +33 (0)1 49 93 19 69

www.saftbatteries.com

Doc. N° 31072-2-0909

Information in this document is subject to change without notice and becomes contractual only after written confirmation by Saft.

For more details on primary lithium technologies please refer to Primary Lithium Batteries Selector Guide Doc N° 31048-2.

Published by the Communications Department.

Photo credit: Saft

Société anonyme au capital de 31 944 000 €
RCS Bobigny B 383 703 873

Produced by Arthur Associates Limited.



SAFT