

# Self-contained Photoelectric Sensors

## PZ2 Series

### Features

- World's smallest photoelectric sensors
- Excellent mirror surface detection
- IP-67 rated waterproof
- Sensors can operate side-by-side

### Detecting Distance

Thrubeam – 7000 mm (275.59")



Retro-reflective with Polarized filter – 2500 mm (98.43")



Diffuse-reflective – 100 to 600 mm (3.94" to 23.62")



## Description

### Greatly improved serviceability

Mounting the sensor body and routing the cable can be performed independently, reducing time and labor.

If replacing the sensor body with a new one because of damage, or if replacing the sensor body with a different model because of changes in specifications, you have only to replace the sensor body.



### Highly durable metallic trimmer head

Unlike conventional plastic head models, a metallic head cannot easily be defaced or cracked.



### Side-by-side installation of two sensors

The PZ2-41(P), PZ2-42(P), and PZ2-61(P) can operate at alternate-frequencies, enabling two sensors to be mounted in close proximity.

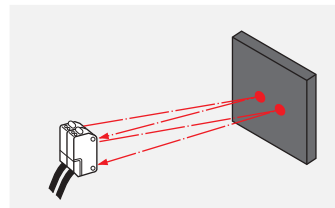

### Newly developed P.R.O. function

P.R.O. function: The PZ2-61's optical system is constructed so that the transmitter emits only the horizontal component of the light wave through the horizontal polarizing filter and the receiver receives only the vertical component through the vertical polarizing filter. This allows mirror-surfaced targets to be detected stably.



- Photoelectric Sensors
- Safety Light Curtain
- Proximity Sensors
- Pressure Sensors
- PLCs
- Counters, Timers
- Bar Code Readers
- Vision Systems
- High Precision Sensors
- Displacement Sensors
- Thrubeam Measuring
- Analog Sensor Controllers
- Video Microscopes
- FS-V20
- FS01
- FS2
- LV
- CZ
- PZ-V/M
- PZ2**
- PZ-101
- PS01
- PS
- PQ
- PG
- PI-G
- PW

## Applications

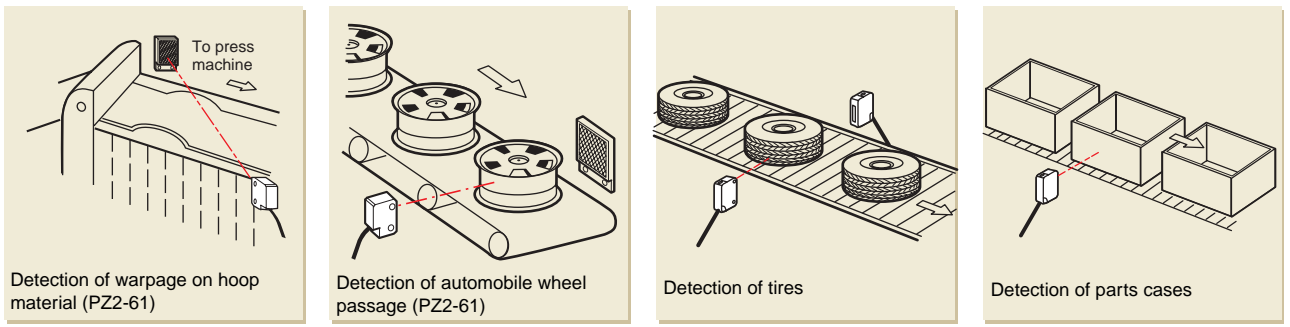

## Selection Chart

Type		Detecting distance		Model
Thrubeam	Long-range		7 m 23.0'	PZ2-51 PZ2-51P
	Short-range		60 cm 23.62"	
Retro-reflective	Polarized		2.5 m 8.2'	PZ2-61 PZ2-61P
Diffuse-reflective	Long-range		10 cm 3.94"	PZ2-41 PZ2-41P  PZ2-42 PZ2-42P
	Short-range		60 cm 23.62"	

### A-3 attachment kit (optional) specially designed for PZ2-51 and -51P thrubeam models

Slit plate only			Slit plate and polarizing filter			Polarizing filter only	
Slit width	Detecting distance	Target size	Slit width	Detecting distance	Target size	Detecting distance	Target size
0.5 mm 0.02"	500 mm 19.69"	0.5 x 5 mm 0.02" x 0.20"	0.5 mm 0.02"	200 mm 7.87"	0.5 x 5 mm 0.02" x 0.20"	2500 mm 98.43"	6 x 6 mm 0.24"
1 mm 0.04"	800 mm 31.50"	1 x 5 mm 0.04" x 0.20"	1 mm 0.04"	400 mm 15.75"	1 x 5 mm 0.04" x 0.20"		
2 mm 0.08"	1500 mm 59.06"	2 x 5 mm 0.08" x 0.20"	2 mm 0.08"	700 mm 27.56"	2 x 5 mm 0.08" x 0.20"		

## Support Tool

These easy-to-use mounting tools are designed for use in harsh environments.

**S-P12 Protective cover**  
Protective cover with mounting bracket.  
Thickness: 3.0 mm 0.12"  
(Stainless steel).



**S-P01 Free adjuster**  
Free-adjustable height and angle.  
Both vertical and horizontal mountings are available.



- Photoelectric Sensors
- Safety Light Curtain
- Proximity Sensors
- Pressure Sensors
- PLCs
- Counters, Timers
- Bar Code Readers
- Vision Systems
- High Precision Sensors
- Displacement Sensors
- Thrubeam Measuring
- Analog Sensor Controllers
- Video Microscopes

- FS-V20
- FS01
- FS2
- LV
- CZ
- PZ-V/M
- PZ2**
- PZ-101
- PS01
- PS
- PQ
- PG
- PI-G
- PW

## Specifications

Type	Thrubeam	Retro-reflective		Diffuse-reflective	
		Polarized	Long-range	Short-range	
Model	NPN	PZ2-51	PZ2-61	PZ2-41	PZ2-42
	PNP	PZ2-51P	PZ2-61P	PZ2-41P	PZ2-42P
Detecting distance		7000 mm 275.59"	2500 mm 98.43" (with R-2)	600 mm 23.62" (200 x 200 mm 7.87" white mat paper)	100 mm (100 x 100 mm 3.94" white mat paper)
Detectable object		Opaque materials (8 x 8 mm 0.31" min.)	Opaque materials (30 x 30 mm 1.18" min.)	Transparent and opaque materials	
Hysteresis		—		20% max. of detecting distance	
Response time		1.5 ms max.	1 ms max. (2 ms in alternate frequency mode <sup>1)</sup> )		
Light source		Visible red LED			
Sensitivity adjustment		1-turn trimmer (240°)			
Operation mode		LIGHT-ON/DARK-ON (switch-selectable)			
Indicators		Output and power <sup>2)</sup> : Red LED, Stable operation: Green LED			
Control output		NPN or PNP: 100 mA (40 V) max., Residual voltage: 1 V max.			
Protection circuit		Reversed polarity, overcurrent protection, surge absorber			
Power supply		12 to 24 VDC ±10%			
Current consumption		T: 20 mA max. R: 25 mA max.	35 mA max.		
Enclosure rating		IP-67			
Ambient light		Incandescent lamp: 5,000 lux max., Sunlight: 20,000 lux max.			
Ambient temperature		-20 to +55°C (-4 to +131°F), No freezing			
Relative humidity		35 to 85%, No condensation			
Housing		Glass-fiber reinforced plastic			
Weight (including 2-m 6.6' connector cable)		Transmitter/receiver: Approx. 50 g each	Approx. 50 g		

1. The different-frequency type has "D" at the end of the model No. PZ-41D(P)/42D(P)/61D only.  
 2. The power indicator is equipped with the PZ2-51 only.

## Connections

### NPN

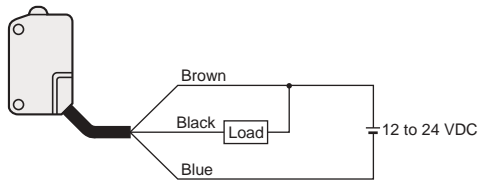

### Using the light emission stop input (Transmitter of PZ2-51)

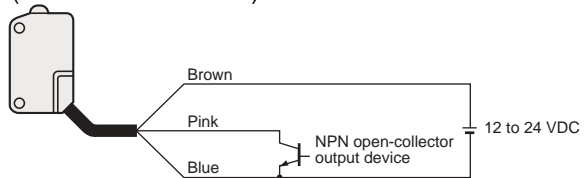

### PNP

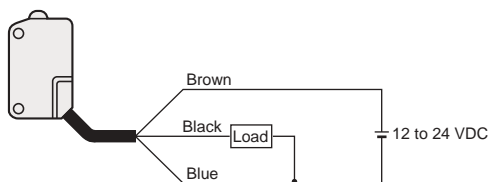

### [Note]

Signals from equipment with a PNP output cannot be input. When not using the light emission stop input, cut the root of the pink wire or connect it with the brown wire.

Photoelectric Sensors
Safety Light Curtain
Proximity Sensors
Pressure Sensors
PLCs
Counters, Timers
Bar Code Readers
Vision Systems
High Precision Sensors
Displacement Sensors
Thrubeam Measuring
Analog Sensor Controllers
Video Microscopes

## Input/Output Circuits

### NPN

#### PZ2-61/41/42/51 (Receiver)

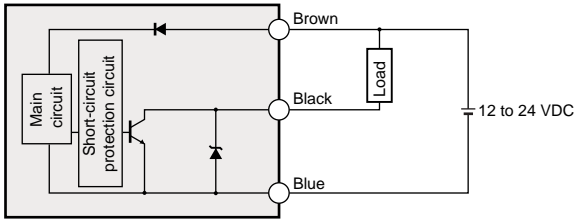

### PNP

#### PZ2-61P/62P/41P/42P/51P (Receiver)

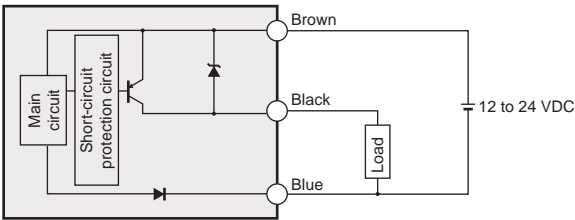

#### PZ2-51/51P (Transmitter)

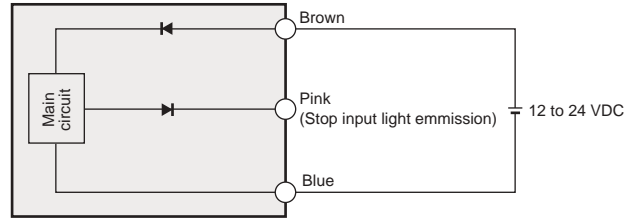

## Adjustment

### Switching between LIGHT-ON and DARK-ON modes

Set the operation mode selector switch to "L" (right) to select the LIGHT-ON mode (L.ON). Set the switch to "D" (left) to select the DARK-ON mode (D.ON).

### Thrubeam

DARK-ON mode



1. With no target, turn the trimmer to "Max.". With the receiver in place, move the transmitter up/down and right/left. Set it at the midpoint of the range where the green LED is lit. Mount the transmitter and continue the adjustment in the same way.

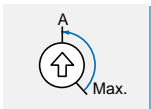

2. Turn the trimmer counterclockwise from Max. until the green LED turns off. – Point A

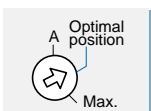

3. Set the trimmer midway between point A and Max. Confirm sensor operation.

### Reflective

LIGHT-ON mode (When DARK-ON mode is specified, refer to words in parentheses.)



1. With no target, turn the trimmer until the red LED lights (turns off). – Point A  
If the LED does not light (turn off) with the trimmer at max., use max. as point A.

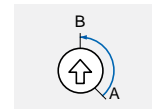

2. With the target in place, turn the trimmer counterclockwise until the green LED turns off. – Point B

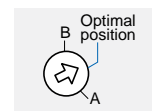

3. Set the trimmer midway between points A and B. Confirm sensor operation.

FS-V20
FS01
FS2
LV
CZ
PZ-V/M
<b>PZ2</b>
PZ-101
PS01
PS
PQ
PG
PI-G
PW

## Characteristics

### Receiver excess gain vs. detecting distance (Typical)

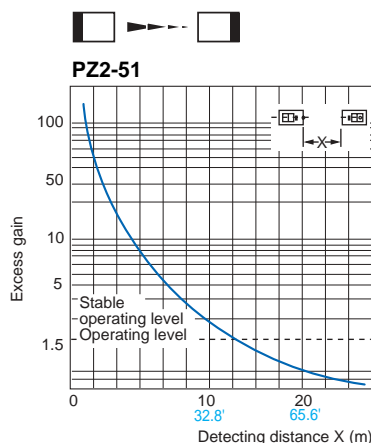
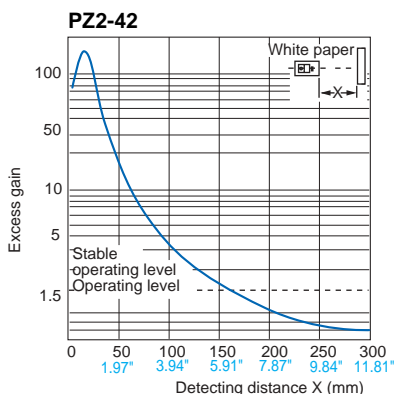
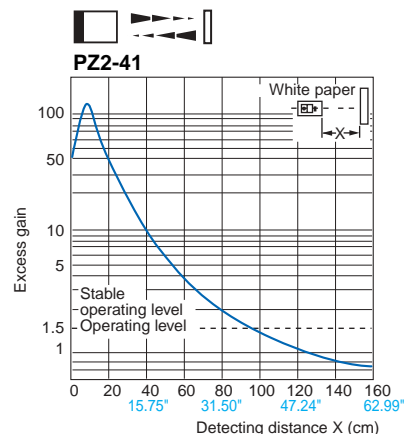
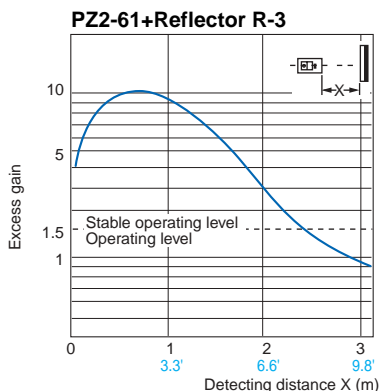
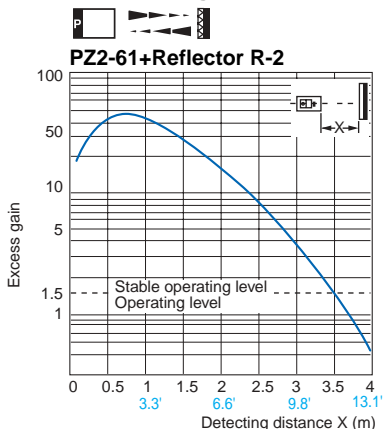

### Operating distance vs. detecting distance (Typical)

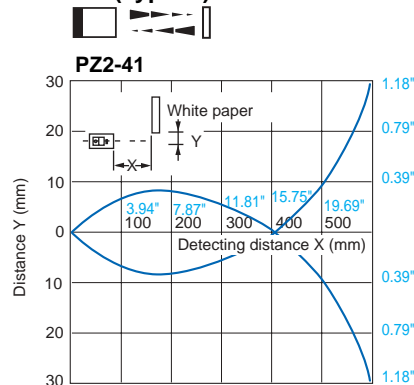

### Parallel displacement of optical axis (Typical)

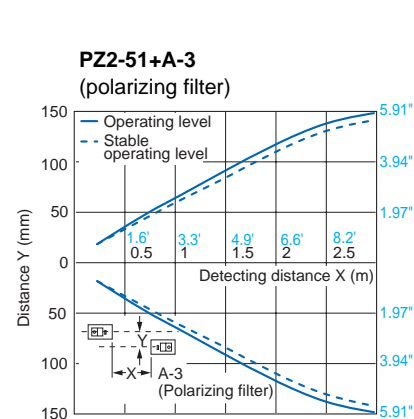
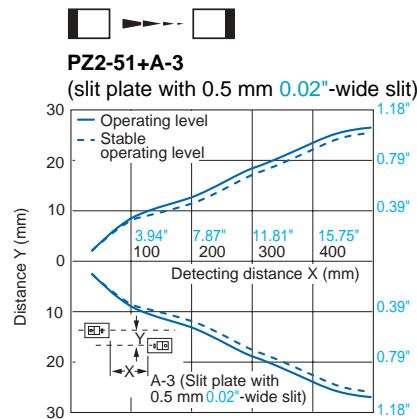
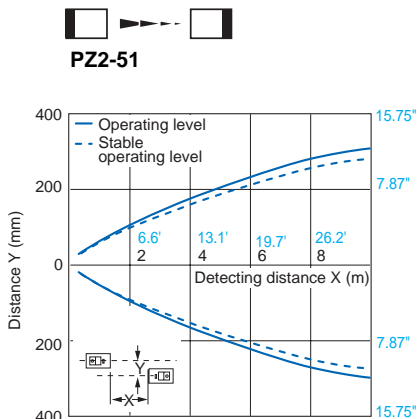
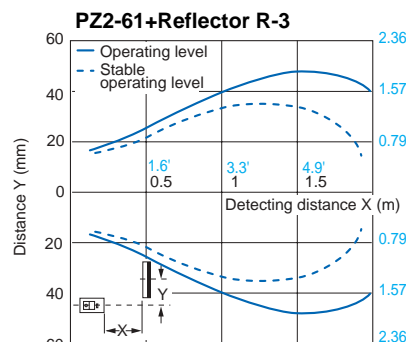
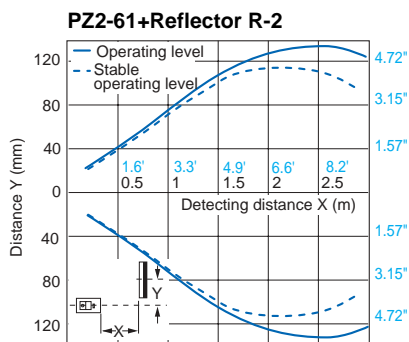
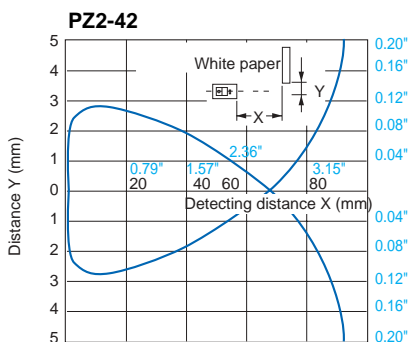

FS-V20

FS01

FS2

LV

CZ

PZ-V/M

**PZ2**

PZ-101

PS01

PS

PQ

PG

PI-G

PW

Photoelectric Sensors

Safety Light Curtain

Proximity Sensors

Pressure Sensors

PLCs

Counters, Timers

Bar Code Readers

Vision Systems

High Precision Sensors

Displacement Sensors

Thrubeam Measuring

Analog Sensor Controllers

Video Microscopes

FS-V20

FS01

FS2

LV

CZ

PZ-V/M

**PZ2**

PZ-101

PS01

PS

PQ

PG

PI-G

PW

**PZ2-51+A-3**  
(slit plate with 0.5 mm 0.02"-wide slit + polarizing filter)

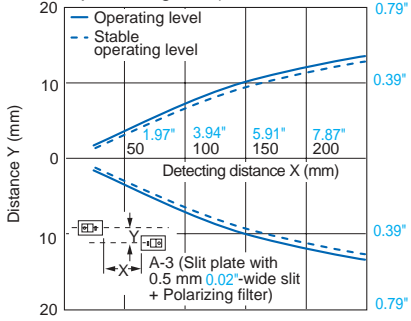

Optical axis angle (Typical)

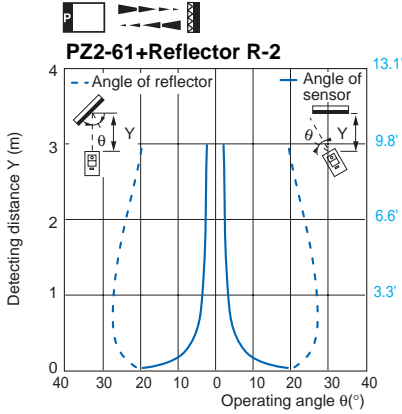

**PZ2-61+Reflector R-3**

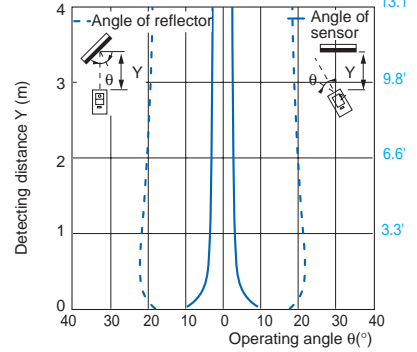

Detecting distance vs. object size (Typical)



**PZ2-51**

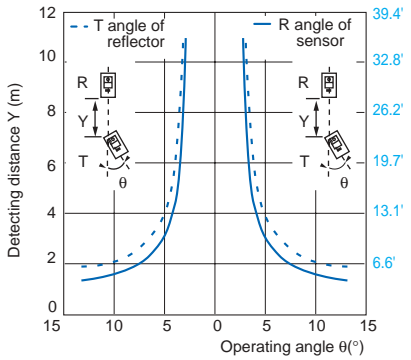

**PZ2-41**

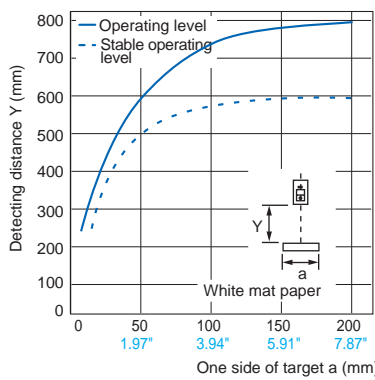

**PZ2-42**

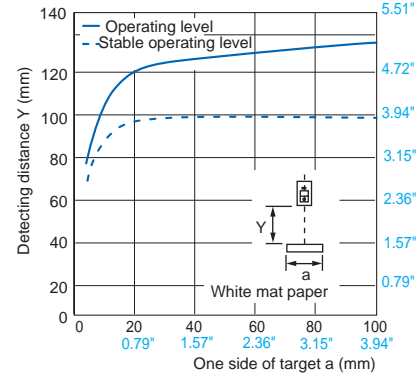

Interference area



**PZ2-61+Reflector R-2**

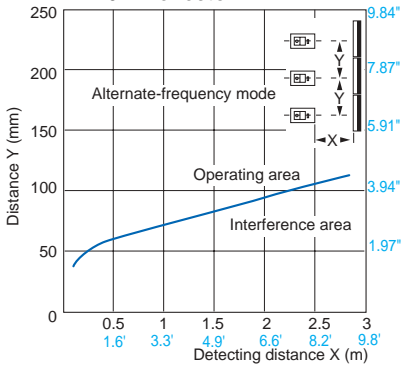

**PZ2-51**

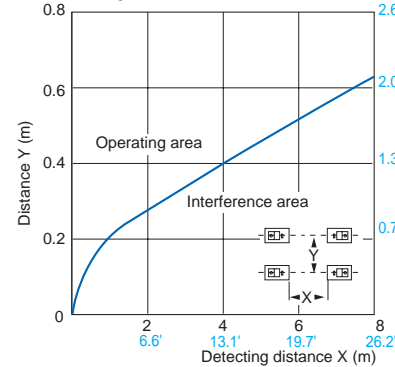

**PZ2-51+A-3**

(slit plate with 0.5 mm 0.02"-wide slit)

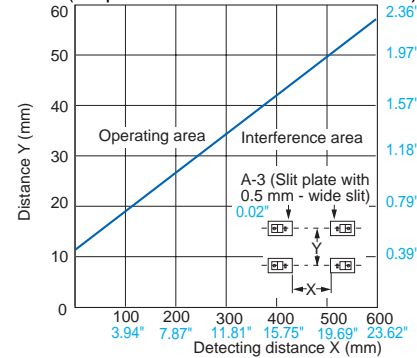

**PZ2-51+A-3**

(polarizing filter)

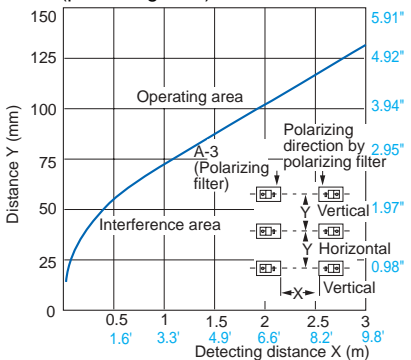

**PZ2-51+A-3**

(slit plate with 0.5 mm 0.02"-wide polarizing filter)

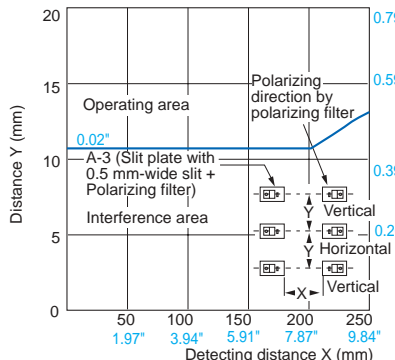

Up to two sensors can be mounted in close proximity.

Up to two sensors can be mounted in close proximity.

- Photoelectric Sensors
- Safety Light Curtain
- Proximity Sensors
- Pressure Sensors
- PLCs
- Counters, Timers
- Bar Code Readers
- Vision Systems
- High Precision Sensors
- Displacement Sensors
- Thrubeam Measuring
- Analog Sensor Controllers
- Video Microscopes

- FS-V20
- FS01
- FS2
- LV
- CZ
- PZ-V/M
- PZ2**
- PZ-101
- PS01
- PS
- PQ
- PG
- PI-G
- PW

## Hints on Correct Use

### Retro-reflective type with P.R.O. function

When the target is of highly glossy plastic or film, the sensor may not detect it stably. To detect such targets stably, tilt the sensor by 10 to 30° in regard to the vertical surface of the traveling target.

### Mounting

Use the special mounting bracket supplied to mount the sensor. According to the mounting location, mount it as illustrated below.

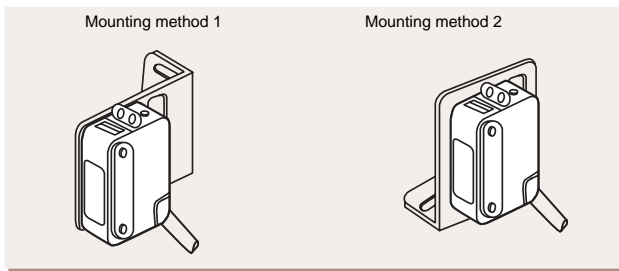

- Mount the sensor at a torque of 0.5 N•m or less.
- With the diffuse-reflective type and retro-reflective type, combination of the normal and alternate-frequency types allows up to two sensors to be mounted in close proximity. (Response time of the alternate-frequency type sensor is 2 ms.) (PZ2-41D(P)/42D(P)/61D only)

#### [Note]

Up to two sensors can be mounted side-by-side. If a third sensor is used, it needs be mounted far enough away from the others so that they do not interfere with each other. Check that the third one does not interfere with the first two under actual detecting conditions, then mount it.

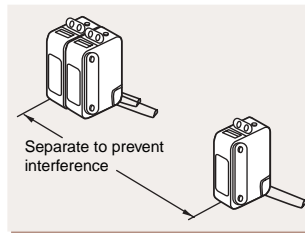

- When two or more thrubeam type sensors are mounted close to each other, alternate the transmitter and receiver. This reduces mutual interference and stabilizes detection. When the detecting distance is 2.5 m [8.2'](#) or less, attach the polarizing filter. This allows you to mount up to two sensors in close proximity.

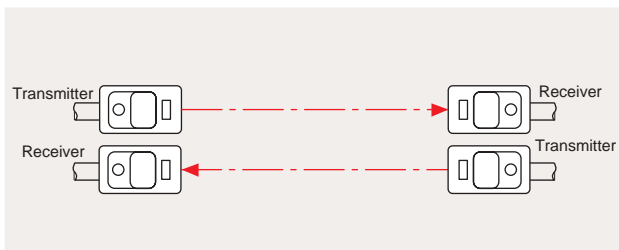

### Handling the connector

Be sure to insert the connector completely then press the lock. If the connector is not inserted completely, the watertightness will be lost.

#### Disconnecting the connector from the sensor

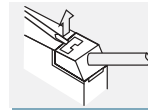

1. Lift the lock using a slim screwdriver, etc. Caution: Do not lift the lock by 1 mm [0.04"](#) or more.

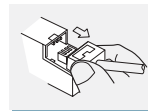

2. While holding the connector, disconnect it from the sensor. Do not pull the cable.

#### Connecting the connector to the sensor

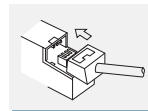

1. Insert the connector into the sensor completely.

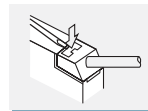

2. Press the lock.

- Excessively frequent connecting and disconnecting deteriorates the packing, causing the watertightness to be lost. Limit the frequency of connecting and disconnecting to 15 times or less.
- The sensor cable has a tensile strength of 5 kg for 1 second maximum. Do not use excessive force to pull the cable.

### Wiring

Limit the cable length to 100 m [328.1'](#) or less.

#### Optional attachment kit specially designed for thrubeam type

Slit plate and polarizing filter (A-3)

- The optional slit plate and/or polarizing filter can be attached to the thrubeam type (PZ2-51 and -51P). To detect or position thin (minute) targets, use the slit plate. And, to prevent mutual interference, use the polarizing filter. Both of the slit plate and polarizing filter can be attached to the sensor at the same time.
- The 3 type slit plates (different in slit width) and polarizing filter are packaged in the A-3 attachment kit. According to the application, use the appropriate attachment.

Photoelectric Sensors
Safety Light Curtain
Proximity Sensors
Pressure Sensors
PLCs
Counters, Timers
Bar Code Readers
Vision Systems
High Precision Sensors
Displacement Sensors
Thrubeam Measuring
Analog Sensor Controllers
Video Microscopes
FS-V20
FS01
FS2
LV
CZ
PZ-V/M
<b>PZ2</b>
PZ-101
PS01
PS
PQ
PG
PI-G
PW

**Dimensions**

► For CAD Data Download >>> <http://www.keyence.com/cadg>

Unit: mm Inch

**PZ2-41(P)/42(P)/61(P)/62(P)**

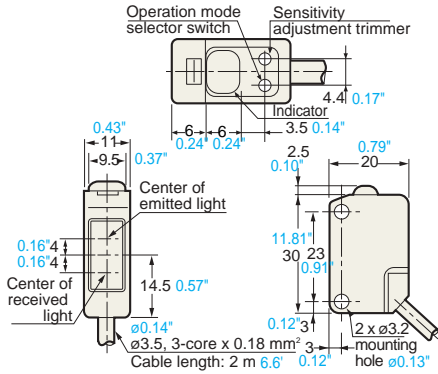

**PZ2-51(P)**

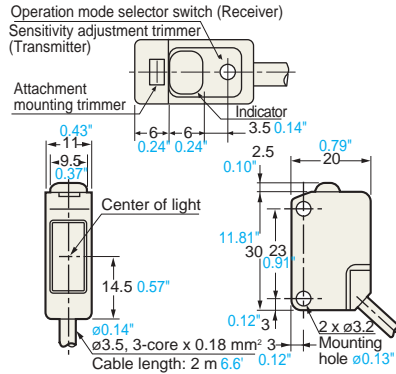

**PZ2 (with mounting bracket)**

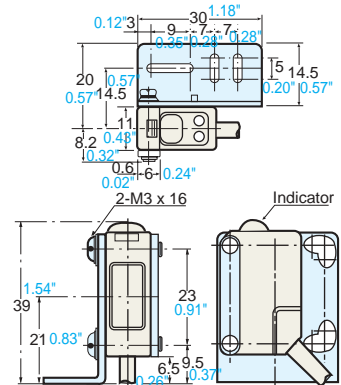

**PZ2-51(P)**

When attachment (A-3) is attached.

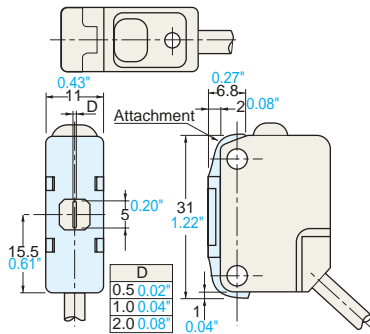

**Mounting bracket (standard)**

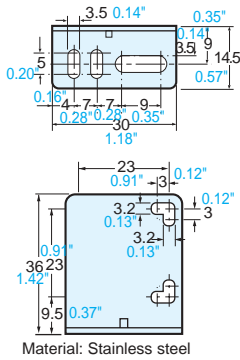

**Flat nut (standard)**

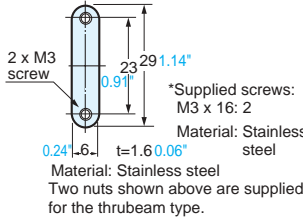

**Reflector R-4 (optional) OP-97225**

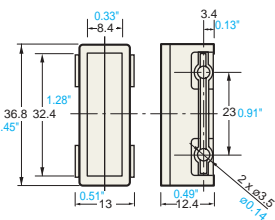

**Connector**

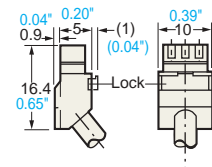

**Reflector R-2 (accessory for PZ2-61)**

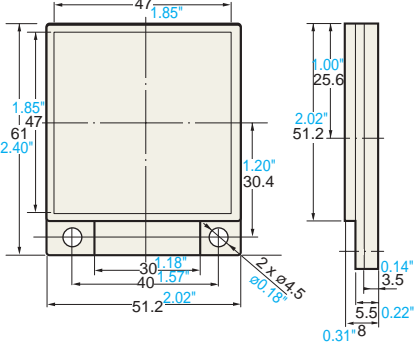

**Reflector R-3 (optional) OP-96436**

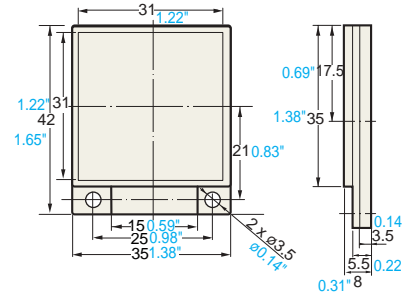

**PRO reflection tape (optional) OP-96629**

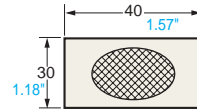

**S-P01**

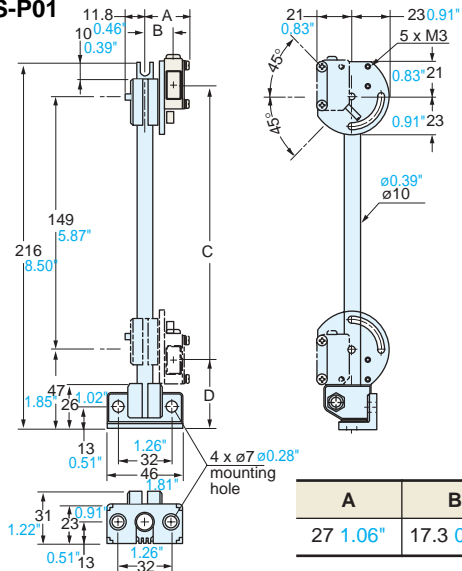

**S-P12**

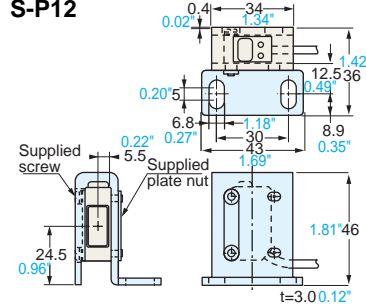

**S-P01 Head**

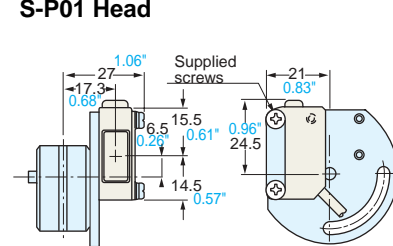

A	B	C	D
27 1.06"	17.3 0.68"	162 6.38"	40.5 1.59"