

SSR Series

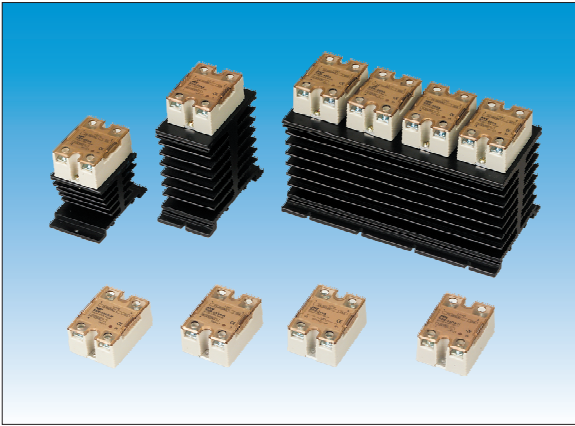

- Built-in operation indicator
- High isolation over than 50MΩ (500VDC)
- High dielectric over than 2.5KV
- Low EMI / EFI & surge by zero cross trigger method
- Output snubber circuit protection

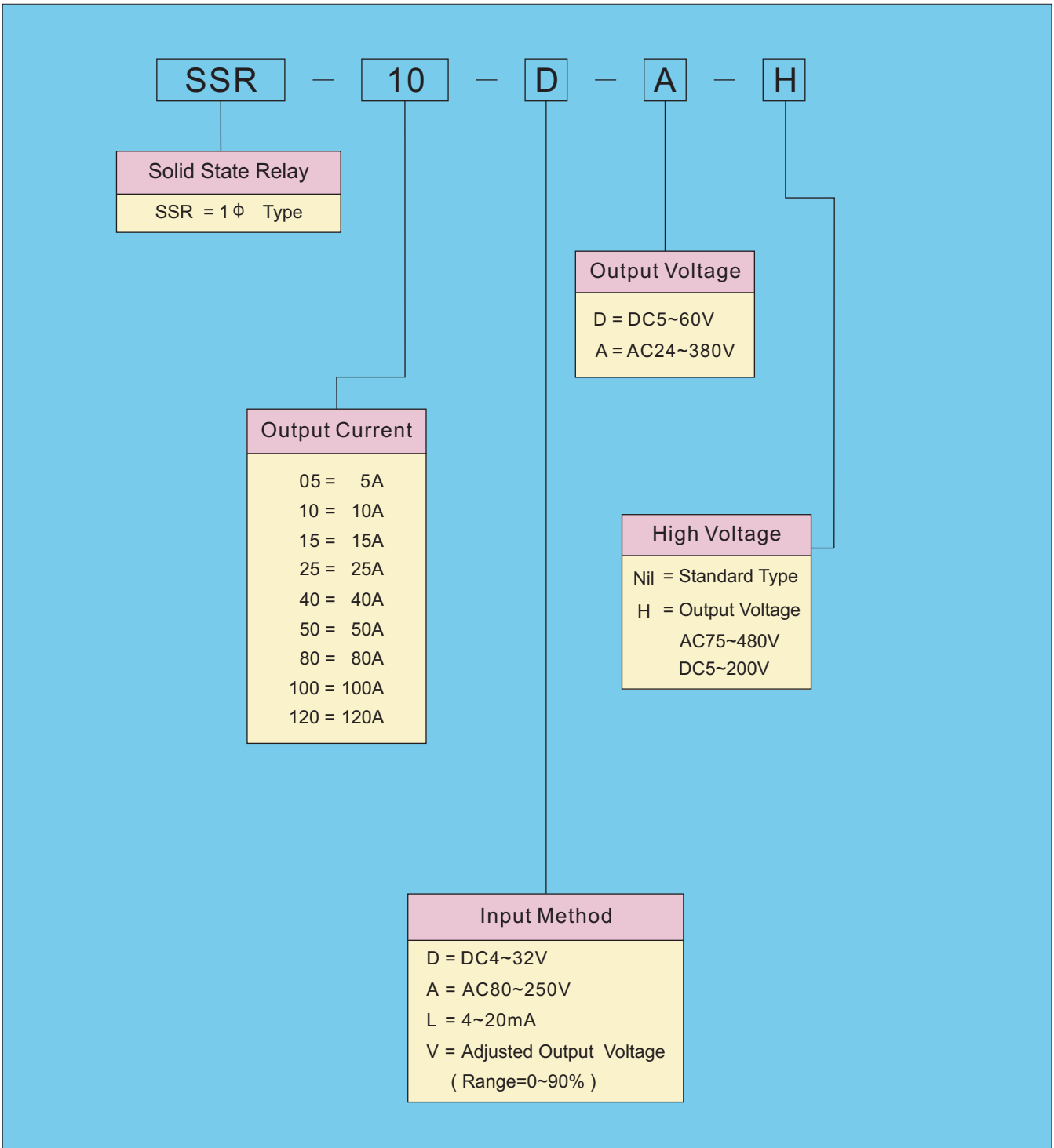

MODEL	SSR-05DA	SSR-10DA	SSR-15DA	SSR-25DA	SSR-40DA	SSR-50DA	SSR-80DA	SSR-100DA	SSR-120DA
LOAD CURRENT	5A	10A	15A	25A	40A	50A	80A	100A	120A
INPUT DATA									
OPERATING VOLTAGE	4~32VDC								
TRIGGER CURRENT	7.5mA/12VDC max								
CONTROL METHOD	Zero Cross Trigger								
OUTPUT DATA									
OPERATING VOLTAGE	24~380VAC								
VOLTAGE DROP	1.6V								
LEAKAGE CURRENT	< 3.0mA								
RESPONSE TIME	ON<10ms, OFF<10ms								
GENERAL DATA									
INSULATION RESISTANCE	Min. 50M $\Omega$ (500VDC)								
DIELECTRIC STRENGTH	2500VAC 50/60 Hz for 1 min								
AMBIENT TEMPERATURE	-20 $^{\circ}$ C ~+80 $^{\circ}$ C								
AMBIENT HUMIDITY	45%~85%RH								
WEIGHT	Appr. 105g								

CONNECTION DIAGRAM

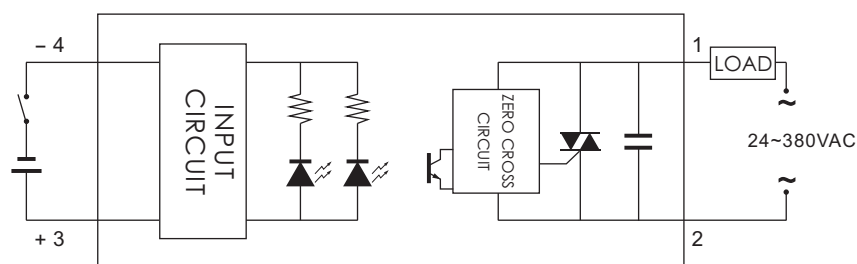

MODEL	SSR-10DA-H	SSR-15DA-H	SSR-25DA-H	SSR-40DA-H	SSR-50DA-H	SSR-80DA-H	SSR-100DA-H	SSR-120DA-H
LOAD CURRENT	10A	15A	25A	40A	50A	80A	100A	120A

**INPUT DATA**

OPERATING VOLTAGE	4~32VDC							
TRIGGER CURRENT	7.5mA/12VDC max							
CONTROL METHOD	Zero Cross Trigger							

**OUTPUT DATA**

OPERATING VOLTAGE	75~480VAC							
VOLTAGE DROP	1.6V							
LEAKAGE CURRENT	< 5.0mA							
RESPONSE TIME	ON<10ms, OFF<10ms							

**GENERAL DATA**

INSULATION RESISTANCE	Min. 50MΩ(500VDC)							
DIELECTRIC STRENGTH	2500VAC 50/60 Hz for 1 min							
AMBIENT TEMPERATURE	-20℃~+80℃							
AMBIENT HUMIDITY	45%~85%RH							
WEIGHT	Appr. 105g							

**CONNECTION DIAGRAM**

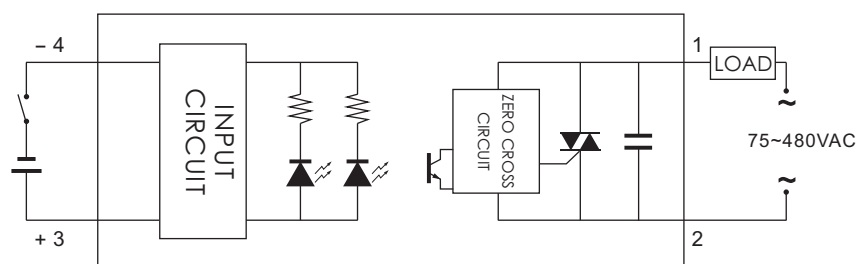

MODEL	SSR-05AA	SSR-10AA	SSR-15AA	SSR-25AA	SSR-40AA	SSR-50AA	SSR-80AA	SSR-100AA	SSR-120AA
LOAD CURRENT	5A	10A	15A	25A	40A	50A	80A	100A	120A
<b>INPUT DATA</b>									
OPERATING VOLTAGE	80~250VAC 50/60Hz								
TRIGGER CURRENT	5.0mA / 110VAC max								
CONTROL METHOD	Zero Cross Trigger								
<b>OUTPUT DATA</b>									
OPERATING VOLTAGE	24~380VAC								
VOLTAGE DROP	1.6V								
LEAKAGE CURRENT	< 3.0mA								
RESPONSE TIME	ON<20ms, OFF<20ms								
<b>GENERAL DATA</b>									
INSULATION RESISTANCE	Min. 50MΩ (500VDC)								
DIELECTRIC STRENGTH	2500VAC 50/60 Hz for 1 min								
AMBIENT TEMPERATURE	-20℃ ~+80℃								
AMBIENT HUMIDITY	45%~85%RH								
WEIGHT	Appr. 100g								

**CONNECTION DIAGRAM**

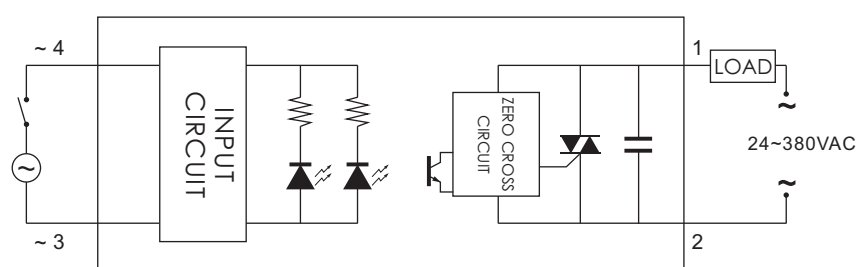

MODEL	SSR-10AA-H	SSR-15AA-H	SSR-25AA-H	SSR-40AA-H	SSR-50AA-H	SSR-80AA-H	SSR-100AA-H	SSR-120AA-H
LOAD CURRENT	10A	15A	25A	40A	50A	80A	100A	120A
INPUT DATA								
OPERATING VOLTAGE	80~250VAC 50/60Hz							
TRIGGER CURRENT	5.0mA / 110VAC max							
CONTROL METHOD	Zero Cross Trigger							
OUTPUT DATA								
OPERATING VOLTAGE	75~480VAC							
VOLTAGE DROP	1.6V							
LEAKAGE CURRENT	< 5.0mA							
RESPONSE TIME	ON<20ms, OFF<20ms							
GENERAL DATA								
INSULATION RESISTANCE	Min. 50MΩ(500VDC)							
DIELECTRIC STRENGTH	2500VAC 50/60 Hz for 1 min							
AMBIENT TEMPERATURE	-20°C ~+80°C							
AMBIENT HUMIDITY	45%~85%RH							
WEIGHT	Appr. 100g							

CONNECTION DIAGRAM

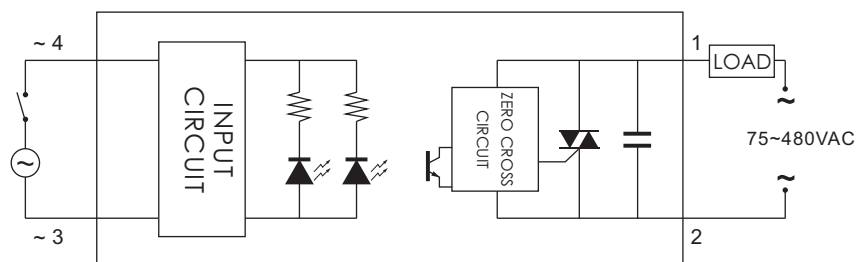

MODEL	SSR-05LA	SSR-10LA	SSR-15LA	SSR-25LA	SSR-40LA	SSR-50LA	SSR-80LA
LOAD CURRENT	5A	10A	15A	25A	40A	50A	80A
INPUT DATA							
TRIGGER CURRENT	4~20mA						
CONTROL METHOD	Zero Cross Trigger						
OUTPUT DATA							
OPERATING VOLTAGE	90~250VAC						
VOLTAGE DROP	1.6V						
LEAKAGE CURRENT	< 3.0mA						
RESPONSE TIME	ON<10ms, OFF<10ms						
GENERAL DATA							
INSULATION RESISTANCE	Min. 50MΩ(500VDC)						
DIELECTRIC STRENGTH	2500VAC 50/60 Hz for 1 min						
AMBIENT TEMPERATURE	-20℃ ~+80℃						
AMBIENT HUMIDITY	45%~85%RH						
WEIGHT	Appr. 105g						

CONNECTION DIAGRAM

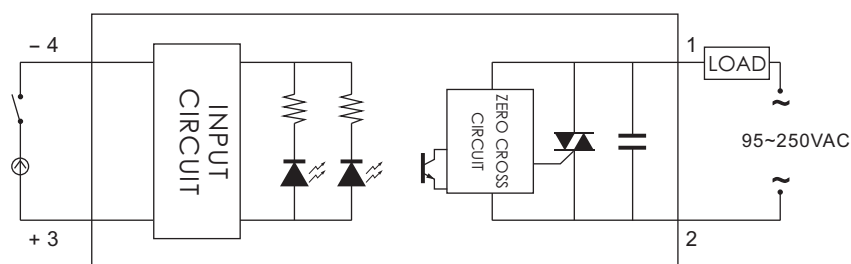

MODEL	SSR-10LA-H	SSR-15LA-H	SSR-25LA-H	SSR-40LA-H	SSR-50LA-H	SSR-80LA-H
LOAD CURRENT	10A	15A	25A	40A	50A	80A
INPUT DATA						
TRIGGER CURRENT	4~20mA					
CONTROL METHOD	Zero Cross Trigger					
OUTPUT DATA						
OPERATING VOLTAGE	250~480VAC					
VOLTAGE DROP	1.6V					
LEAKAGE CURRENT	< 5.0mA					
RESPONSE TIME	ON<10ms, OFF<10ms					
GENERAL DATA						
INSULATION RESISTANCE	Min. 50M $\Omega$ (500VDC)					
DIELECTRIC STRENGTH	2500VAC 50/60 Hz for 1 min					
AMBIENT TEMPERATURE	-20 $^{\circ}$ C ~+80 $^{\circ}$ C					
AMBIENT HUMIDITY	45%~85%RH					
WEIGHT	Appr. 105g					

## CONNECTION DIAGRAM

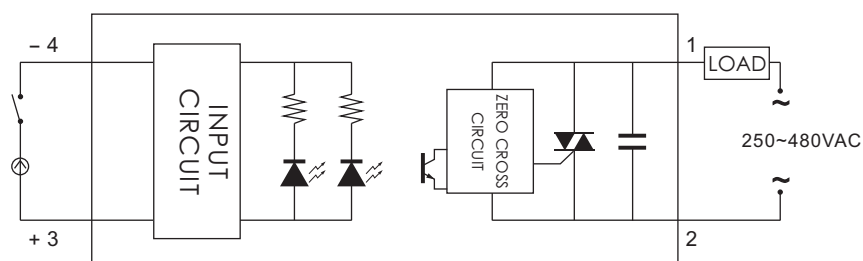

MODEL	SSR-05VA	SSR-10VA	SSR-15VA	SSR-25VA	SSR-40VA	SSR-50VA	SSR-80VA
LOAD CURRENT	5A	10A	15A	25A	40A	50A	80A

INPUT DATA

VARIABLE RESISTANCE	Trimmer 250KΩ /110V, 500KΩ /220V, 1MΩ /380V						
---------------------	---	--	--	--	--	--	--

CONTROL METHOD	Phase Control						
----------------	---------------	--	--	--	--	--	--

OUTPUT DATA

OPERATING VOLTAGE	24~380VAC						
-------------------	-----------	--	--	--	--	--	--

VOLTAGE DROP	1.6V						
--------------	------	--	--	--	--	--	--

LEAKAGE CURRENT	< 5.0mA						
-----------------	---------	--	--	--	--	--	--

GENERAL DATA

INSULATION RESISTANCE	Min. 50MΩ (500VDC)						
-----------------------	--------------------	--	--	--	--	--	--

DIELECTRIC STRENGTH	2500VAC 50/60 Hz for 1 min						
---------------------	----------------------------	--	--	--	--	--	--

AMBIENT TEMPERATURE	-20°C ~+80°C						
---------------------	--------------	--	--	--	--	--	--

AMBIENT HUMIDITY	45%~85%RH						
------------------	-----------	--	--	--	--	--	--

WEIGHT	Appr. 100g						
--------	------------	--	--	--	--	--	--

CONNECTION DIAGRAM

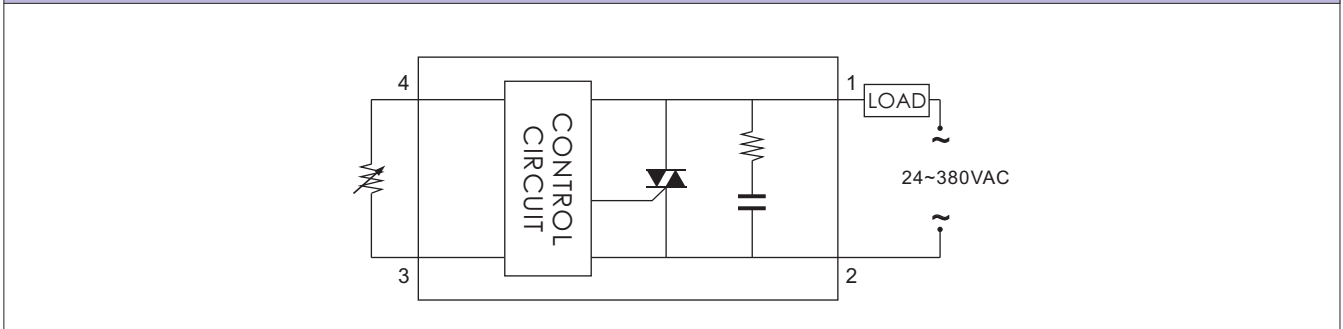



MODEL	SSR-10VA-H	SSR-15VA-H	SSR-25VA-H	SSR-40VA-H	SSR-50VA-H	SSR-80VA-H
LOAD CURRENT	10A	15A	25A	40A	50A	80A

## INPUT DATA

VARIABLE RESISTANCE	Trimmer 250K $\Omega$ /110V, 500K $\Omega$ /220V, 1M $\Omega$ /380V					
CONTROL METHOD	Phase Control					

## OUTPUT DATA

OPERATING VOLTAGE	75~480VAC					
VOLTAGE DROP	1.6V					
LEAKAGE CURRENT	< 5.0mA					

## GENERAL DATA

INSULATION RESISTANCE	Min. 50M $\Omega$ (500VDC)					
DIELECTRIC STRENGTH	2500VAC 50/60 Hz for 1 min					
AMBIENT TEMPERATURE	-20 $^{\circ}$ C ~+80 $^{\circ}$ C					
AMBIENT HUMIDITY	45%~85%RH					
WEIGHT	Appr. 100g					

## CONNECTION DIAGRAM

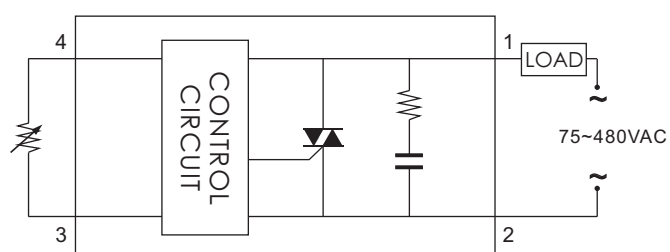

MODEL	SSR-05DD	SSR-10DD	SSR-20DD	SSR-05DD-H	SSR-10DD-H
LOAD CURRENT	5A	10A	20A	5A	10A
INPUT DATA					
OPERATING VOLTAGE	3~32VDC				
TRIGGER CURRENT	7.5mA/12VDC max				
CONTROL METHOD	Isolated by Photocouple				
OUTPUT DATA					
OPERATING VOLTAGE	5~60VDC			5~200VDC	
VOLTAGE DROP	1.6V				
LEAKAGE CURRENT	< 0.8mA				
RESPONSE TIME	1ms <ON+OFF>				
GENERAL DATA					
INSULATION RESISTANCE	Min. 50MΩ (500VDC)				
DIELECTRIC STRENGTH	2500VAC 50/60 Hz for 1 min				
AMBIENT TEMPERATURE	-20°C ~ +80°C				
AMBIENT HUMIDITY	45%~85%RH				
WEIGHT	Appr. 110g				

CONNECTION DIAGRAM

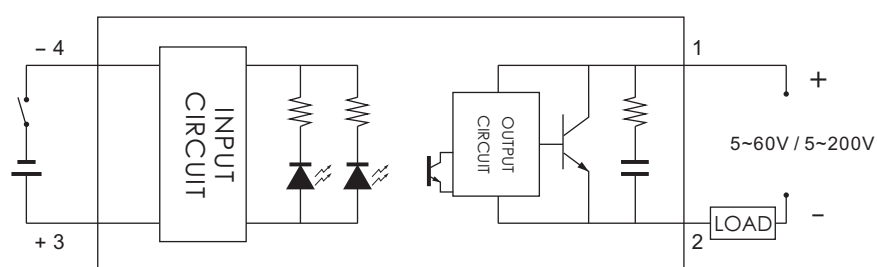

## Control Method Zero Cross Trigger Method

Output TURN ON or TURN OFF  
 Only on zero cross point of sine wave , may avoid surge or EMI / RFI occuring  
 Specially suited to control resistive, capacitive and Non-saturated inductive loads

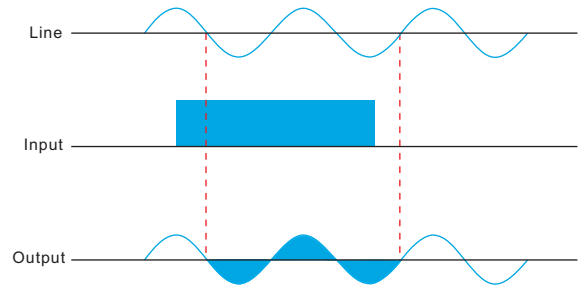

## Variable Resistance Control Method < Trimmer Control >

Power output is controlled by the trigger angle of triac With variable resistor 250K $\Omega$  / 110VAC, 500K $\Omega$  / 220VAC, 1M $\Omega$  / 380V

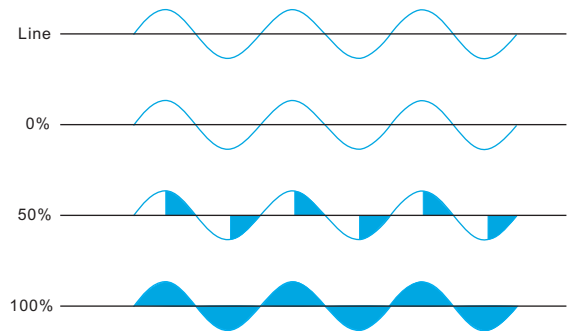

## Referance Data

Max. Allowable Case Temperature

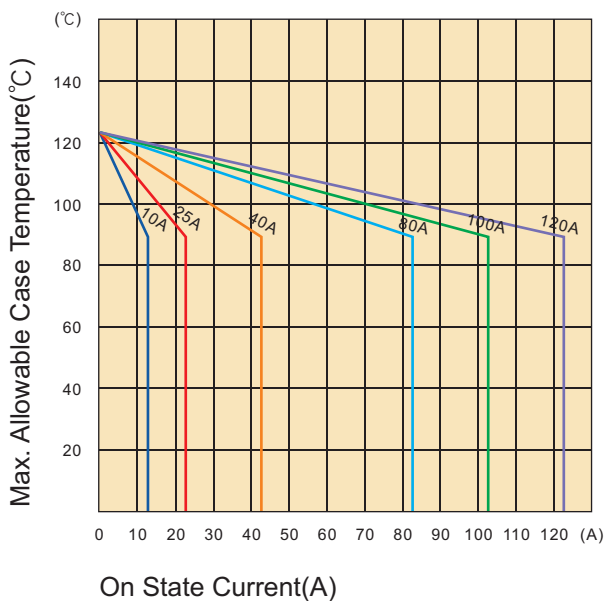

Peak Surge Current/Surge Current Duration

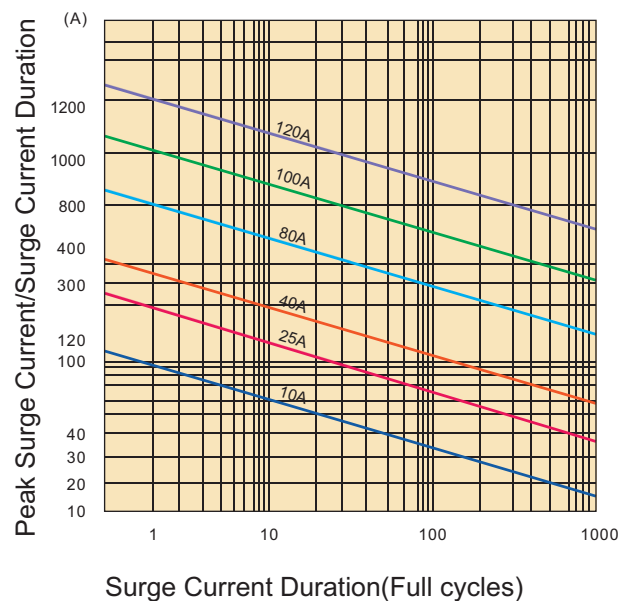

CONNECTION DIAGRAMS

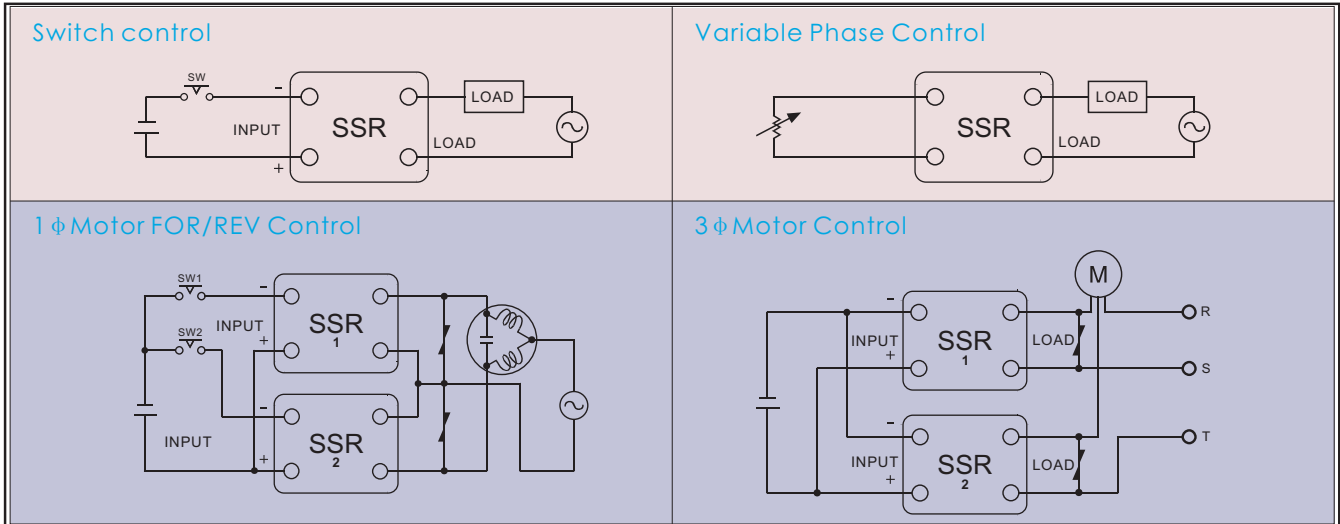

DIMENSIONS

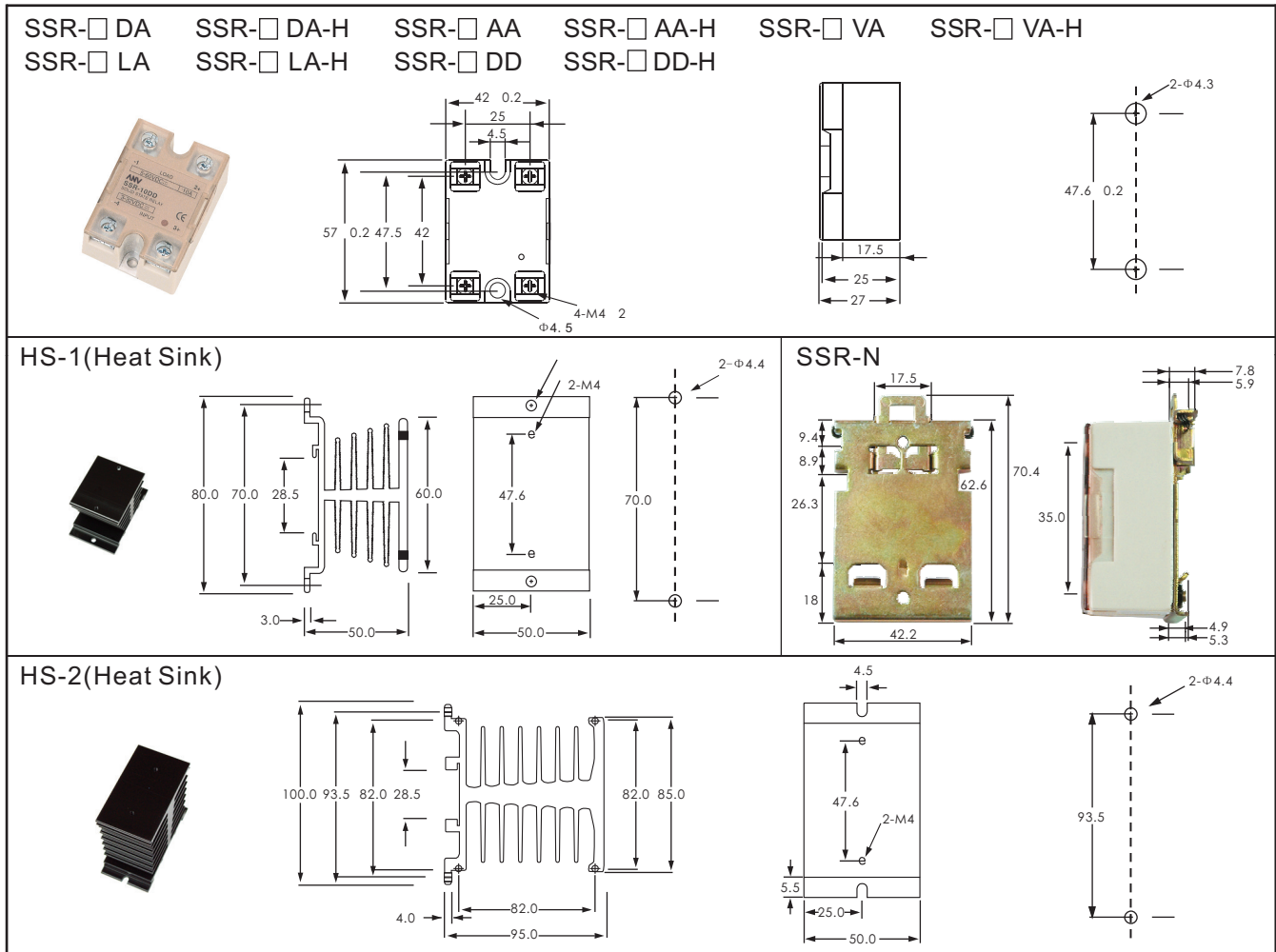

**ANV ANV ANV ELECTRIC CO., LTD.**

**Kaohsiung Headquarter**  
 No. 151, Jin Shan Road, Kaohsiung, Taiwan  
 Tel :+886 7 359 5833 Fax :+886 7 359 5822  
 E-Mail : anv@anv.com.tw

**Tainan Office**  
 No. 60, Lin Sen Road Sec. 1, Tainan, Taiwan  
 Tel :+886 6 216 0988 Fax :+886 6 216 0388  
 E-Mail : tainan@anv.com.tw

**Taichung Office**  
 No. 532, Wen Hsin Road Sec. 1, Taichung, Taiwan  
 Tel :+886 4 2320 9930 Fax :+886 4 2320 9960  
 E-Mail : taichung@anv.com.tw

**ANV ELECTRIC (HK) LTD**  
 Flat 5, 12/F., Yale Ind. Centre, 61-63 Au Pui Wan Street, Fotan, Shatin, N.T., Hong Kong  
 Tel :+852 2690 2588 Fax :+852 2690 2511  
 E-Mail : anv@anv.com.hk

**ANV ELECTRIC (M) SDN. BHD**  
 25-1, Jalan 1/116B, Kuchai Entrepreneur's Park, Off Jalan Kuchai Lama, 58200 Kuala Lumpur, Malaysia  
 Tel :+60 3 7980 3328 Fax :+60 3 7980 3779  
 E-Mail : anv@anv.com.my