



### FEATURES

- RoHS compliant
- Single isolated output
- 1kVDC isolation
- Efficiency up to 80%
- Wide temperature performance at full 1 watt load, -40°C to 85°C
- Power density 1.53W/cm<sup>3</sup>
- UL 94V-0 package material
- Footprint from 0.69cm<sup>2</sup>
- Industry standard pinout
- 5V & 12V input
- 5V, 9V, 12V and 15V output
- No heatsink required
- Internal SMD construction
- Fully encapsulated with toroidal magnetics
- No external components required
- MTTF up to 3.4 million hours
- Custom solutions available
- Pin compatible with LME & NML series
- PCB mounting

### DESCRIPTION

The NME series of DC/DC Converters is particularly suited to isolating and/or converting DC power rails. The galvanic isolation allows the device to be configured to provide an isolated negative rail in systems where only positive rails exist. The wide temperature range guarantees startup from -40°C and full 1 watt output at 85°C. For lower ripple, refer to output ripple reduction section.



### SELECTION GUIDE

Order Code	Nominal Input Voltage	Output Voltage	Output Current	Input Current at Rated Load	Efficiency	Isolation Capacitance	MTTF <sup>1</sup>	Package Style
	V	V	mA	mA	%	pF	kHrs	
NME0505DC	5	5	200	289	69	30	3415	DIP
NME0509DC	5	9	111	260	77	37	3078	
NME0512DC	5	12	83	256	78	33	2205	
NME0515DC	5	15	66	250	80	40	1532	
NME0524DC	5	24	42	248	80	48		
NME0505SC	5	5	200	289	69	30	3415	SIP
NME0509SC	5	9	111	260	77	37	3078	
NME0512SC	5	12	83	256	78	33	2205	
NME0515SC	5	15	66	250	80	40	1532	
NME0524SC	5	24	42	248	80	48		
NME1205DC	12	5	200	120	69	33	2493	DIP
NME1209DC	12	9	111	115	74	48	2311	
NME1212DC	12	12	83	105	76	55	1780	
NME1215DC	12	15	66	110	75	52	1313	
NME1205SC	12	5	200	120	69	33	2493	
NME1209SC	12	9	111	115	74	48	2311	
NME1212SC	12	12	83	110	76	55	1780	
NME1215SC	12	15	66	111	75	52	1313	

When operated **with** additional external load capacitance the rise time of the input voltage will determine the maximum external capacitance value for guaranteed start up. The slower the rise time of the input voltage the greater the maximum value of the additional external capacitance for reliable start up.

### INPUT CHARACTERISTICS

Parameter	Conditions	Min.	Typ.	Max.	Units
Voltage range	Continuous operation, 5V input types	4.5	5.0	5.5	V
	Continuous operation, 12V input types	10.8	12.0	13.2	
Reflected ripple current			26	48	mA p-p

### OUTPUT CHARACTERISTICS

Parameter	Conditions	Min.	Typ.	Max.	Units
Rated Power <sup>2</sup>	T <sub>A</sub> = -40°C to 120°C			1.0	W
Voltage Set Point Accuracy	See tolerance envelope				
Line regulation	High V <sub>IN</sub> to low V <sub>IN</sub>		1.0	1.2	%/%
Load Regulation <sup>2</sup>	10% load to rated load, 5V output types		14	15	%
	10% load to rated load, 9V output types		9	10	
	10% load to rated load, 12V output types		7.5	9.5	
	10% load to rated load, 15V output types		7.0	8.5	
	10% load to rated load, 24V output types		5.5	7.5	
Ripple and Noise	BW=DC to 20MHz, 5V output types		85	110	mV p-p
	BW=DC to 20MHz, 9V output types		60	75	
	BW=DC to 20MHz, 12V output types		50	65	
	BW=DC to 20MHz, 15V output types		40	55	
	BW=DC to 20MHz, 24V output types		140	180	

### ABSOLUTE MAXIMUM RATINGS

Short-circuit protection <sup>3</sup>	1 second
Lead temperature 1.5mm from case for 10 seconds	300°C
Internal power dissipation	450mW
Input voltage V <sub>IN</sub> , NME05 types	7V
Input voltage V <sub>IN</sub> , NME12 types	15V

1. Calculated using MIL-HDBK-217F FN2 with nominal input voltage at full load.

2. See derating curve.

3. Supply voltage must be disconnected at the end of the short circuit duration.

All specifications typical at T<sub>A</sub>=25°C, nominal input voltage and rated output current unless otherwise specified.

ISOLATION CHARACTERISTICS					
Parameter	Conditions	Min.	Typ.	Max.	Units
Isolation test voltage	Flash tested for 1 second	1000			VDC
Resistance	Viso= 1000VDC		10		GΩ

GENERAL CHARACTERISTICS					
Parameter	Conditions	Min.	Typ.	Max.	Units
Switching frequency	5V input types		110		kHz
	12V input types		145		

TEMPERATURE CHARACTERISTICS					
Parameter	Conditions	Min.	Typ.	Max.	Units
Specification	All output types	-40		85	°C
Storage		-50		130	
Case Temperature above ambient	5V output types			41	
	All other output types			32	
Cooling	Free air convection				

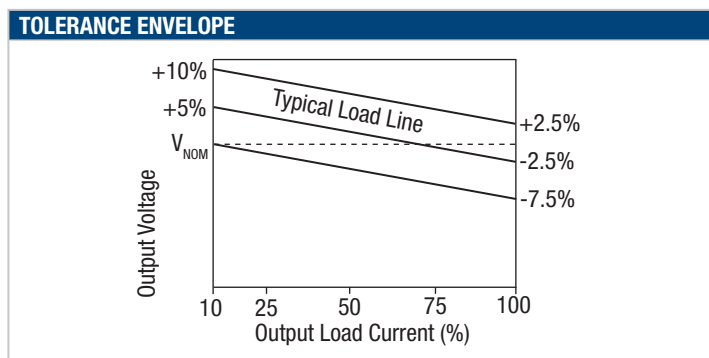
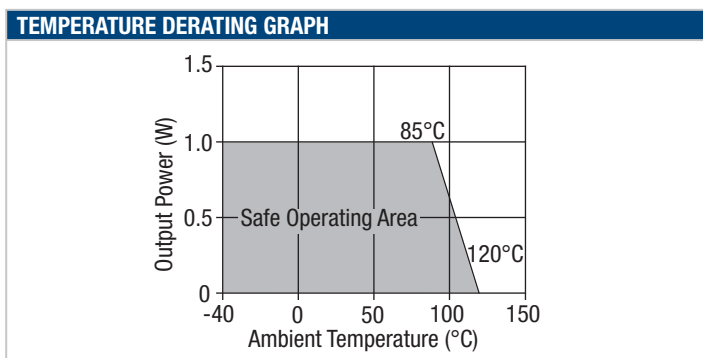

## TECHNICAL NOTES

### ISOLATION VOLTAGE

'Hi Pot Test', 'Flash Tested', 'Withstand Voltage', 'Proof Voltage', 'Dielectric Withstand Voltage' & 'Isolation Test Voltage' are all terms that relate to the same thing, a test voltage, applied for a specified time, across a component designed to provide electrical isolation, to verify the integrity of that isolation.

Murata Power Solutions NME series of DC/DC converters are all 100% production tested at their stated isolation voltage. This is 1kVDC for 1 second.

A question commonly asked is, "What is the continuous voltage that can be applied across the part in normal operation?"

For a part holding no specific agency approvals, such as the NME series, both input and output should normally be maintained within SELV limits i.e. less than 42.4V peak, or 60VDC. The isolation test voltage represents a measure of immunity to transient voltages and the part should never be used as an element of a safety isolation system. The part could be expected to function correctly with several hundred volts offset applied continuously across the isolation barrier; but then the circuitry on both sides of the barrier must be regarded as operating at an unsafe voltage and further isolation/insulation systems must form a barrier between these circuits and any user-accessible circuitry according to safety standard requirements.

### REPEATED HIGH-VOLTAGE ISOLATION TESTING

It is well known that repeated high-voltage isolation testing of a barrier component can actually degrade isolation capability, to a lesser or greater degree depending on materials, construction and environment. The NME series has toroidal isolation transformers, with no additional insulation between primary and secondary windings of enameled wire. While parts can be expected to withstand several times the stated test voltage, the isolation capability does depend on the wire insulation. Any material, including this enamel (typically polyurethane) is susceptible to eventual chemical degradation when subject to very high applied voltages thus implying that the number of tests should be strictly limited. We therefore strongly advise against repeated high voltage isolation testing, but if it is absolutely required, that the voltage be reduced by 20% from specified test voltage.

This consideration equally applies to agency recognized parts rated for better than functional isolation where the wire enamel insulation is always supplemented by a further insulation system of physical spacing or barriers.

### OUTPUT RIPPLE REDUCTION

By using the values of inductance and capacitance stated, the output ripple at the rated load is lowered to 5mV p-p max.

#### Component selection

**Capacitor:** Ceramic chip capacitors are recommended. It is required that the ESR (Equivalent Series Resistance) should be as low as possible, X7R types are recommended. The voltage rating should be at least twice (except for 15V output), the rated output voltage of the DC/DC converter.

**Inductor:** The rated current of the inductor should not be less than that of the output of the DC/DC converter. At the rated current, the DC resistance of the inductor should be such that the voltage drop across the inductor is <2% of the rated voltage of the DC/DC converter. The SRF (Self Resonant Frequency) should be >20MHz.

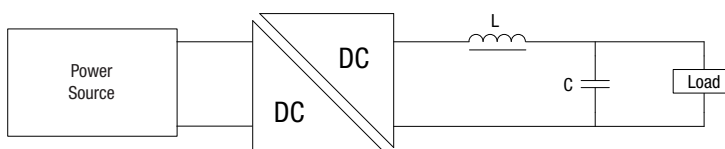

Order Code	L (µH)	Inductor Order Codes		C (µF)
		SMD	Through Hole	
NME0505XC	47	82473C	22R473C	4.70
NME0509XC	47	82473C	22R473C	1.00
NME0512XC	68	82683C	22R683C	1.00
NME0515XC	100	82104C	22R104C	0.47
NME0524XC	330	82334C	22R334C	1.00
NME1205XC	100	82104C	22R104C	4.70
NME1209XC	47	82473C	22R473C	1.00
NME1212XC	68	82683C	22R683C	0.47
NME1215XC	100	82104C	22R104C	0.47

Product specification for MPS inductors can be found at:

2200R Series (Through Hole)

[http://www.murata-ps.com/data/magnetics/kmp\\_2200r.pdf](http://www.murata-ps.com/data/magnetics/kmp_2200r.pdf)

8200 Series (SMD)

[http://www.murata-ps.com/data/magnetics/kmp\\_8200c.pdf](http://www.murata-ps.com/data/magnetics/kmp_8200c.pdf)

## PACKAGE SPECIFICATIONS

### MECHANICAL DIMENSIONS

DIP Package

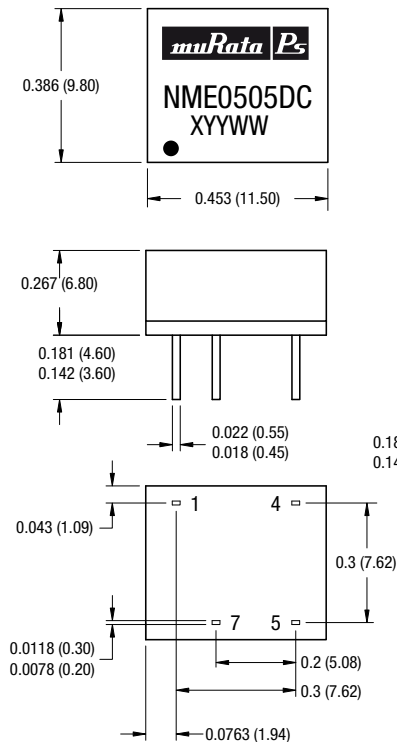

SIP Package

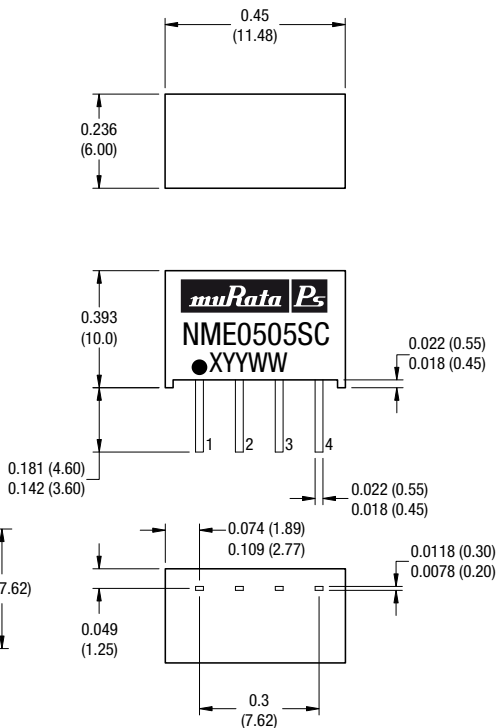

All dimensions in inches  $\pm 0.01$  (mm  $\pm 0.25$ mm). All pins on a 0.1 (2.54) pitch and within  $\pm 0.01$  (0.25) of true position.

Weight: 1.30g (SIP) 1.48g (DIP)

### PIN CONNECTIONS - 8 PIN DIP

Pin	Function
1	-VIN
4	+VIN
5	+VOUT
7	-VOUT

### PIN CONNECTIONS - 4 PIN SIP

Pin	Function
1	-VIN
2	+VIN
3	-VOUT
4	+VOUT

**PACKAGE SPECIFICATIONS (continued)**

**RECOMMENDED FOOTPRINT DETAILS**

8 Pin DIP Package

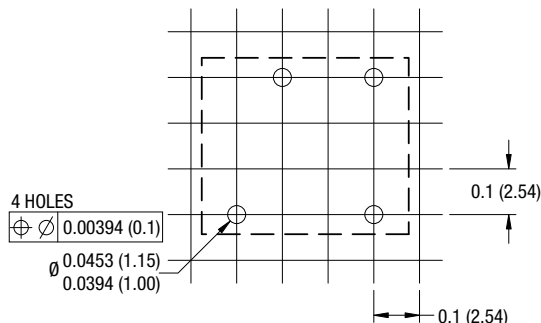

4 Pin SIP Package

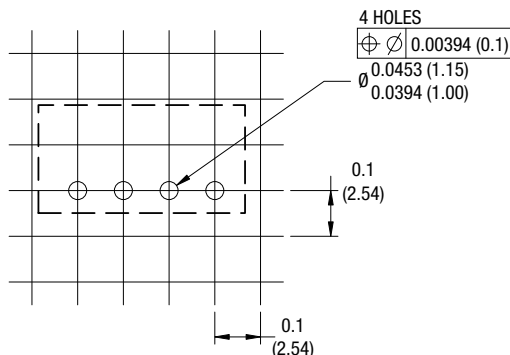

**TUBE OUTLINE DIMENSIONS**

8 Pin DIP Tube

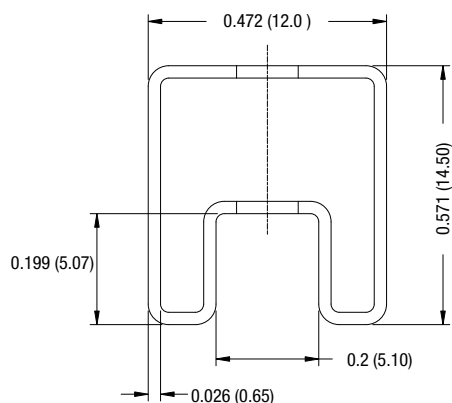

4 Pin SIP Tube

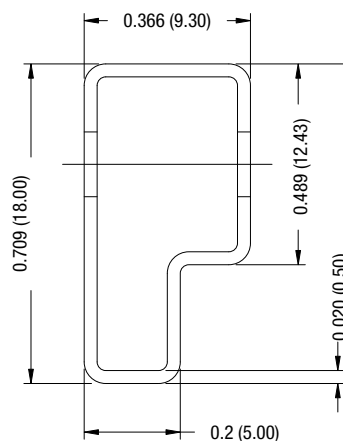

Unless otherwise stated all dimensions in inches (mm)  $\pm 0.5$ mm.

Tube length (8 Pin DIP) : 20.47 (520mm  $\pm 2$ mm).

Tube length (4 Pin SIP) : 20.47 (520mm  $\pm 2$ mm).

Tube Quantity : 35

**RoHS COMPLIANCE INFORMATION**



This series is compatible with RoHS soldering systems with a peak wave solder temperature of 300°C for 10 seconds. The pin termination finish on the SIP package type is Tin Plate, Hot Dipped over Matte Tin with Nickel Preplate. The DIP types are Matte Tin over Nickel Preplate. Both types in this series are backward compatible with Sn/Pb soldering systems.

For further information, please visit [www.murata-ps.com/rohs](http://www.murata-ps.com/rohs)